

Catalogo Prodotti
2021

Assotherm
Point Milano

IT: Presentazione

FR: Présentation



In breve

Assotherm Point Milano, con sede a Opera in Provincia di Milano, è una realtà italiana introdotta nella produzione e distribuzione di prodotti e sistemi per la realizzazione del comfort climatico e del risparmio energetico e succursale dell'azienda Assotherm srl.

Con la sua struttura divisionale, Assotherm Point Milano è riconosciuta come un interlocutore primario nella predisposizione di prodotti e servizi che consentono la realizzazione di impianti di riscaldamento e di climatizzazione sia attraverso la gestione dell'acqua che dell'aria, così come sistemi per la distribuzione ed intercettazione dei fluidi e tecnologie per l'isolamento termico ed acustico degli impianti.

Assotherm Point Milano si propone come un valido partner nel campo dell'impiantistica meccanico-tecnologica offrendo un servizio che prevede anche la personalizzazione o la realizzazione di prodotti secondo i parametri del cliente.

Assotherm Point Milano vanta la sua presenza ed offre i suoi servizi in tutto il Nord Italia, garantendo condizioni flessibili e consegne rapide degli ordini.

Tabella scontistiche

Famiglia Prodotto	Pagina	Sconto	

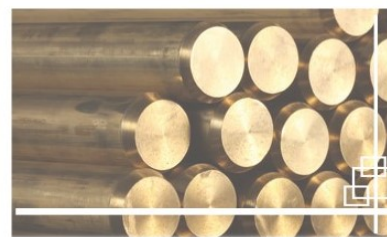

Assotherm Point Milano srl

IT—20090 Opera (MI)

Via Cesare Pavese, 4

Tel. +39 02 844038305

E-mail info@assotherm-point-milano.com

www.assotherm-point-milano.com

DVGW type examination certificate
DVGW-Baumusterprüfzertifikat

DVGW CERT
REGISTRATION NUMBER: DW-8511C00275

Field of Application
products of water supply
Produkte der Wasserversorgung

Distributor
Assotherm Srl
Via Fratelli Calvi 7, I-24060 Casazza

Product Category
Installation systems and system joints; pipe joint for pipes in drinking water installation systems (E511)

Product Description
system joints designed as compressing joints made of stainless steel for pipes made of stainless steel according to DVGW-working sheet GW 541; unpressed leaky

Model
PRESS-INOX

Test Reports
laboratory control test: V353/18 from 04.10.2018 (IMA)
type testing: B217/13.2 from 10.10.2014 (IMA)
type testing: B217/13.1 from 10.10.2013 (IMA)

Test Basis
DVGW W 534 (01.05.2004)
UBA ELASTOM (16.03.2016)
DVGW W 270 (01.11.2007)
UBA METALLE (26.03.2018)

Date of Expiry / File No.
01.10.2023 / 18-0607-WVN

08.11.2018 Ci C-12
DVGW CERT GmbH is an authorized body for testing according to DIN EN 10204:2004 for certification of products for energy and water supply systems.

DVGW CERT GmbH is an authorized body for testing according to DIN EN 10204:2004 for certification of products for energy and water supply systems.

kiwa
Partner for progress

TYPGODKÄNNANDEBEVIS 1241
MED BESLUT OM TILLVERKNINGSKONTROLL

SAKORD: Presskoppling

Produktnamn: FCC PRESS-STEEL Presskoppling
Presskoppling för tryckrör av stål. Presskopplingarna utformas med specialutvecklad, enligtslagig tätning och tryckspårning. Presskopplingarna är tillgängliga för diametrar 12, 14, 16, 22, 28, 34, 42 och 54 mm.

Avsedd användning
Vid montage tillämpas med godkända skruvar i rostfällstål. Kan kopplingarna användas för system inne i ett rum och utrustning som byggande.

Godkännande
Produkten är tillverkad enligt tillhörande tekniska specifikationer och är godkänd för användning i tryckledningar för tryck upp till 1 MPa. Produkten kan levereras utomhus för system med temperaturer upp till +10 °C.

Godkännande gäller för kontinuerlig trycktestning upp till 10 MPa vid 20 °C vid högsta tillåtna 1 MPa. Produkten kan levereras utomhus för system med temperaturer upp till +10 °C.

Beholdningsdatum: 2014-10-31
Gäller till: 2019-10-30
Diameter: 650/14

DVGW-Baumusterprüfzertifikat
DVGW type examination certificate

DVGW CERT
REGISTRATION NUMBER: DW-6102CT0568

Anwendungsbereich
Produkte der Wasserversorgung
products of water supply

Zertifizierter Hersteller
Assotherm Srl
Via F.lli Calvi, 7, I-24060 Casazza (Bergamo)

Verleiher
Assotherm Srl
Via F.lli Calvi, 7, I-24060 Casazza (Bergamo)

Produktkategorie
Absperrarmaturen für Trinkwasser: Kugelhahn (E102)

Produktbeschreibung
Kugelhahn in Durchgangsform mit vollem Durchgang für die Trinkwasserinstallation

Modell
SILVER

Prüfberichte
Baumusterprüfung: 20181027 vom 27.10.2018 (ITR)
UBA-Listine: KA 0155/16 vom 10.08.2016 (TZW)
Mikrobiologische Prüfung: MO 058/16 vom 11.07.2016 (TZW)

Prüfgrundlagen
DVGW W 570-1 (01.03.2013)
DIN EN 13829 (01.12.2005)
UBA METALLE (26.03.2018)
UBA KTW (07.03.2016)
DVGW W 270 (01.11.2007)

Ablaufdatum / AZ
date of expiry / file no. 27.10.2023 / 18-0575-WNE

24.01.2018 Fx A-12
DVGW CERT GmbH is an authorized body for testing according to DIN EN 10204:2004 for certification of products for energy and water supply systems.

DVGW CERT GmbH is an authorized body for testing according to DIN EN 10204:2004 for certification of products for energy and water supply systems.

ASSOTHERM SRL
Via Fratelli Calvi, 7 - 24060 Casazza (Bergamo) - ITALY
+39 035 813182 +39 035 816692 info@assotherm.com
CFIVAT 0337940166 - REA Company registered N° 372594

CERTIFICATE
The Pressure Equipment Directive 97/23/EC

Below signatory, in representation of the Company:

ASSOTHERM SRL
Via Fratelli Calvi, 7
24060 CASAZZA (BG) - ITALY

CERTIFIES THAT

Assotherm srl as a material Manufacturer and Distributor for the scope of Longitudinal welded pipes (E-220) and Fittings (E-235) in Carbon Steel Zinc Plated

has implemented, operates, and maintains a quality-assurance system in accordance with the Pressure Equipment Directive 97/23/EC Annex I, paragraph 4.3.

The manufacturer is therefore, authorized to issue certificates of specific product control within the scope of the assessed quality system and in accordance with the Pressure Equipment Directive 97/23/EC and applied technical specifications.

Authorized signature: Cassazza, on July 01, 2015

Cian Michele Pasinelli
Technical Manager
ASSOTHERM SRL

RegistrolEI
Agente di registrazione UE

ASSOTHERM S.R.L.
LEI: 815460630869520C838
CASAZZA, Italy

OTHER ENTITY NAMES	not available
TRANSLATED/OTHER ENTITY NAMES	not available
REGISTRATION AUTHORITY ID	RA000462
OTHER REGISTRATION AUTHORITY ID	not available
REGISTRATION AUTHORITY ENTITY ID	0337940166
LEGAL JURISDICTION	IT
ENTITY CATEGORY	not available
OTHER LEGAL FORM CODE	0922
OTHER LEGAL FORM	SOCIETÀ A RESPONSABILITÀ LIMITATA
ASSOCIATED ENTITY	not available
STATUS ENTITY	ACTIVE
EXPIRATION DATE	not available
OPERATION REASON	not available
SUCCESSOR ENTITY	not available
LEGAL ADDRESS	HEADQUARTERS ADDRESS
VIA F.LLI CALVI, 7	VIA F.LLI CALVI, 7
24060	24060
CASAZZA	CASAZZA
IT	IT
LEI INITIAL REGISTRATION DATE	2016-02-25 18:31:26.000+01:00
LEI LATEST UPDATE DATE	2019-02-25 18:31:26.000+01:00
STATUS OF REGISTRATION	ISSUED
LEI NEXT RENEWAL DATE	2020-02-25 18:31:26.000+01:00
MANAGING BODY	815460630869520C838 Informatica S.p.A. Società Controllata di Informatica della Camera di Commercio Italiana per Azioni (Informatica)
VALIDATION SOURCES	FULLY CORROBORATED
VALIDATION AUTHORITY ID	RA000462
OTHER VALIDATION AUTHORITY ID	not available
VALIDATION AUTHORITY ENTITY ID	0337940166

Il certificato LEI è generato da Registro LEI (www.registrolEI.it). I dati LEI sono raccolti dal database CLEP (www.clep.org). Registro LEI non è responsabile per l'accuratezza dei dati.

www.registrolEI.it
08.04.2019

Registro LEI Italia info@registrolEI.it www.registrolEI.it

kiwa
Partner for progress

Numero KIP-483097/01
Emesso 01.06.2014
Rapporto 110500418

Sottilezze S.p.A.
Prima emissione 01.06.2014
Contratto K15-07

CERTIFICATO DI PRODOTTO KIWA-UNI
PRODUCT CERTIFICATE KIWA-UNI

Kiwa Italia dichiara che i prodotti
Ovali della serie di cui è il prodotto
Sistemi multistrato per il trasporto di acqua calda e fredda all'interno degli edifici
Multi-layer piping systems for hot and cold water installation inside building

Marchio del sistema/System Trade mark: SAMPLAST TUBO MULTISTRATO

Model	Type and Nominal dia and wall thickness	Layer Material	Application class/Pressure	Fittings
M4-Pipe dn 16x2,0	PE-NA/Al/PE-NA	2 and 5/10 bar	Steel pipe fittings grade TR1415 G	
M4-Pipe dn 20x2,0	PE-NA/Al/PE-NA	2 and 5/10 bar	Steel pipe fittings grade TR1415 G	
M4-Pipe dn 25x2,0	PE-NA/Al/PE-NA	2 and 5/10 bar	Steel pipe fittings grade TR1415 G	
M4-Pipe dn 32x2,0	PE-NA/Al/PE-NA	2 and 5/10 bar	Steel pipe fittings grade TR1415 G	

In base ai test di tipo non distruttivo alle ispezioni periodiche condotte da Kiwa secondo norme tecniche contenute al requisito del Documento Tecnico KIP-1, sono risultate nella normativa UNI EN ISO 9001 e al D.M. 174/2006 e quindi secondo Kiwa-UNI.

Il presente certificato viene rilasciato in accordo al Regolamento Kiwa Italia per la Certificazione di prodotti ed è composto da 3 pagine.
This certificate is issued in accordance with the Kiwa Italia regulations for Product Certification and consists of 3 pages.

Kiwa Italia
Accredita
Accredia
Accredia

Kiwa Italia
Ing. Emanuele Ferraro
Product Certification Director.

kiwa UNI
IT-DT-K10410



:: Pag. 5 .Sistemi a pressare

Pag. 6 .Raccordi acciaio al carbonio
Pag. 9 .Raccordi acciaio INOX AISI 316L
Pag. 13 .Raccordi rame
Pag. 15 .Raccordi per multistrato

:: Pag. 19 .Sistemi a stringere

Pag. 20 .Raccordi per multistrato
Pag. 22 .Raccordi bicono per rame
Pag. 24 .Raccordi per polietilene

:: Pag. 26 .Sistemi filettati

Pag. 27 .Raccordi ottone
Pag. 31 .Raccordi INOX
Pag. 33 .Raccordi in ghisa malleabile

:: Pag. 38 .Sistemi a saldare

Pag. 39 .Raccordi rame
Pag. 41 .Raccordi nero saldare

:: Pag. 42 .Valvolame e rubinetteria

Pag. 43 .Valvole a sfera
Pag. 47 .Valvole varie ottone

:: Pag. 53 .Prodotti riscaldamento

Pag. 54 .Valvole radiatore

:: Pag. 57 .Collettori di distribuzione

Pag. 58 .Collettori sanitario
Pag. 59 .Collettori riscaldamento
Pag. 62 .Collettori radiante

:: Pag. 64 .Staffaggio

:: Pag. 68 .Sistemi radiante a pavimento

:: Pag. 71 .Vasi espansione

:: Pag. 74 .Isolanti per tubazioni



:: Pag. 5 .Systèmes à sertir

Pag. 6 .Acier carbone
Pag. 9 .Acier inoxydable AISI 316L
Pag. 13 .Cuivre
Pag. 15 .Multicouche

:: Pag. 19 .Systèmes à compression

Pag. 20 .Multicouche
Pag. 22 .Cuivre bicones
Pag. 24 .Polyéthylène

:: Pag. 26 .Systèmes à visser

Pag. 27 .Laiton
Pag. 31 .Inox 316L
Pag. 33 .Fonte malleable

:: Pag. 38 .Systèmes à souder

Pag. 39 .Cuivre
Pag. 41 .Acier carbone

:: Pag. 42 .Vannes et robinetterie

Pag. 43 .Robinets boisseau spheriques
Pag. 47 .Vannes laiton

:: Pag. 53 .Produits chauffage

Pag. 54 .Robinets radiateur

:: Pag. 57 .Collecteurs

Pag. 58 .Collecteurs sanitaires
Pag. 59 .Collecteurs chauffage
Pag. 62 .Collecteurs plancher chauffant

:: Pag. 64 .Supports et chevillage

:: Pag. 68 .Plancher chauffant

:: Pag. 71 .Vases d'expansion

:: Pag. 74 .Isolants pour tuyauterie

Sistemi a pressare



IT: Raccordi a pressione in acciaio al carbonio (IPC-RAC)

FR: Raccords acier-carbone à sertir (IPC-RAC)

Profilo di Pressatura: "M" - Profile de sertissage: "M"

RAC 270



IT: Manicotto con battuta a pressare
FR: Manchon à sertir

Codice	Misura	Box	€
RAC270000150	15	10	1.98
RAC270000180	18	10	2.07
RAC270000220	22	10	2.29
RAC270000280	28	10	2.99
RAC270000350	35	4	5.70
RAC270000420	42	2	7.61
RAC270000540	54	2	9.11
RAC270000760	76	1	31.48
RAC270000890	89	1	40.04
RAC270001080	108	1	53.53

RAC 271



IT: Raccordo diritto maschio
FR: Manchon à sertir male

Codice	Misura	Box	€
RAC271005150	1/2"-15	10	5.85
RAC271005180	1/2"-18	10	5.95
RAC271005220	1/2"-22	10	7.03
RAC271007180	3/4"-18	10	6.84
RAC271007220	3/4"-22	10	6.87
RAC271007280	3/4"-28	10	11.05
RAC271010220	1"-22	10	9.64
RAC271010280	1"-28	10	9.36
RAC271010350	1"-35	4	16.16
RAC271012350	1 1/4"-35	4	15.87
RAC271015420	1 1/2"-42	4	17.52
RAC271020540	2"-54	2	29.19
RAC271025760	2 1/2"-76	1	109.75
RAC271030890	3"-89	1	174.45
RAC271040108	4"-108	1	178.86

RAC 280



IT: Raccordo diritto femmina
FR: Manchon à sertir femelle

Codice	Misura	Box	€
RAC280005150	1/2"-15	10	5.99
RAC280005180	1/2"-18	10	6.10
RAC280005220	1/2"-22	10	7.51
RAC280007180	3/4"-18	10	7.35
RAC280007220	3/4"-22	10	7.41
RAC280010220	1"-22	10	11.98
RAC280010280	1"-28	10	9.80
RAC280012350	1 1/4"-35	4	15.92
RAC280015420	1 1/2"-42	4	27.63
RAC280020540	2"-54	2	32.85

RAC 90



IT: Curva a pressione femmina
FR: Coude à sertir

Codice	Misura	Box	€
RAC090000150	15	10	3.01
RAC090000180	18	10	3.34
RAC090000220	22	10	3.80
RAC090000280	28	10	5.09
RAC090000350	35	4	11.86
RAC090000420	42	2	19.77
RAC090000540	54	2	25.53
RAC090000760	76	1	54.14
RAC090000890	89	1	77.11
RAC090001080	108	1	111.92

RAC 92



IT: Curva a pressione M/F
FR: Coude à sertir M/F

Codice	Misura	Box	€
RAC092000150	15	10	3.01
RAC092000180	18	10	3.34
RAC092000220	22	10	3.80
RAC092000280	28	10	5.09
RAC092000350	35	4	11.86
RAC092000420	42	2	19.77
RAC092000540	54	1	25.53
RAC092000760	76	1	54.15
RAC092000890	89	1	77.11
RAC092001080	108	1	111.92

RAC 120



IT: Curva a pressione a 45° femmina
FR: Coude 45° à sertir

Codice	Misura	Box	€
RAC120000150	15	10	3.50
RAC120000180	18	10	3.63
RAC120000220	22	10	3.88
RAC120000280	28	10	5.21
RAC120000350	35	4	11.36
RAC120000420	42	2	14.31
RAC120000540	54	2	20.02
RAC120000760	76	1	52.96
RAC120000890	89	1	76.60
RAC120001080	108	1	104.17

IT: Raccordi a pressare in acciaio al carbonio (IPC-RAC)

FR: Raccords acier-carbone à sertir (IPC-RAC)

Profilo di Pressatura: "M" - Profile de sertissage: "M"

RAC 121



IT: Curva a pressare a 45° M/F
FR: Coude 45° à sertir M/F

Codice	Misura	Box	€
<u>RAC121000150</u>	15	10	<u>3.50</u>
<u>RAC121000180</u>	18	10	<u>3.63</u>
<u>RAC121000220</u>	22	10	<u>3.88</u>
<u>RAC121000280</u>	28	10	<u>5.21</u>
<u>RAC121000350</u>	35	4	<u>11.36</u>
<u>RAC121000420</u>	42	2	<u>14.31</u>
<u>RAC121000540</u>	54	2	<u>20.02</u>
<u>RAC121000760</u>	76	1	<u>53.12</u>
<u>RAC121000890</u>	89	1	<u>76.60</u>
<u>RAC121001080</u>	108	1	<u>104.17</u>

RAC 261



IT: Curva uscita filetto maschio
FR: Coude à sertir male

Codice	Misura	Box	€
<u>RAC261005150</u>	1/2"-15	10	<u>9.16</u>
<u>RAC261005180</u>	1/2"-18	10	<u>9.57</u>
<u>RAC261007220</u>	3/4"-22	10	<u>12.18</u>
<u>RAC261010280</u>	1"-28	4	<u>15.00</u>

RAC 262



IT: Curva uscita filetto femmina
FR: Coude à sertir femelle

Codice	Misura	Box	€
<u>RAC262005150</u>	1/2"-15	10	<u>12.05</u>
<u>RAC262005180</u>	1/2"-18	10	<u>12.87</u>
<u>RAC262007220</u>	3/4"-22	10	<u>15.49</u>
<u>RAC262010280</u>	1"-28	4	<u>17.82</u>

RAC 130



IT: Tee a pressare
FR: Tee à sertir

Codice	Misura	Box	€
<u>RAC130000150</u>	15	10	<u>5.58</u>
<u>RAC130000180</u>	18	10	<u>6.08</u>
<u>RAC130000220</u>	22	10	<u>6.43</u>
<u>RAC130000280</u>	28	4	<u>8.43</u>
<u>RAC130000350</u>	35	2	<u>14.96</u>
<u>RAC130000420</u>	42	2	<u>22.34</u>
<u>RAC130000540</u>	54	1	<u>26.88</u>
<u>RAC130000760</u>	76	1	<u>104.44</u>
<u>RAC130000890</u>	89	1	<u>124.67</u>
<u>RAC130001080</u>	108	1	<u>160.26</u>

RAC 130F



IT: Tee uscita filetto femmina
FR: Tee à sertir femelle

Codice	Misura	Box	€
<u>RAC130F05150</u>	15-1/2"-15	10	<u>7.92</u>
<u>RAC130F05180</u>	18-1/2"-18	10	<u>7.92</u>
<u>RAC130F05220</u>	22-1/2"-22	10	<u>8.20</u>
<u>RAC130F05280</u>	28-1/2"-28	10	<u>9.34</u>
<u>RAC130F05350</u>	35-1/2"-35	4	<u>15.82</u>
<u>RAC130F05420</u>	42-1/2"-42	2	<u>23.46</u>
<u>RAC130F05540</u>	54-1/2"-54	1	<u>27.48</u>
<u>RAC130F07280</u>	28-3/4"-28	4	<u>11.92</u>
<u>RAC130F07350</u>	35-3/4"-35	2	<u>19.77</u>
<u>RAC130F07420</u>	42-3/4"-42	1	<u>27.42</u>
<u>RAC130F07540</u>	54-3/4"-54	1	<u>28.85</u>
<u>RAC130F07760</u>	76-3/4"-76	1	<u>86.21</u>
<u>RAC130F07890</u>	89-3/4"-89	1	<u>121.10</u>
<u>RAC130F07108</u>	108-3/4"-108	1	<u>143.79</u>

RAC 131



IT: Tee a pressare doppia riduzione
FR: Tee sertir double réduit

Codice	Misura	Box	€
<u>RAC131221515</u>	22-15-15	10	<u>9.43</u>
<u>RAC131222215</u>	22-22-15	10	<u>9.59</u>
<u>RAC131282222</u>	28-22-22	5	<u>12.97</u>
<u>RAC131282822</u>	28-28-22	5	<u>13.11</u>

IT: Raccordi a pressare in acciaio al carbonio (IPC-RAC)

FR: Raccords acier-carbone à sertir (IPC-RAC)

Profilo di Pressatura: "M" - Profile de sertissage: "M"

RAC 131



IT: Tee a pressare ridotto
FR: Tee à sertir réduit

Codice	Misura	Box	€
RAC131015180	18-15-18	10	<u>7.33</u>
RAC131015220	22-15-22	10	<u>6.10</u>
RAC131018220	22-18-22	10	<u>6.34</u>
RAC131015280	28-15-28	10	<u>8.07</u>
RAC131018280	28-18-28	10	<u>8.39</u>
RAC131022280	28-22-28	10	<u>8.97</u>
RAC131015350	35-15-35	4	<u>14.10</u>
RAC131018350	35-18-35	4	<u>14.65</u>
RAC131022350	35-22-35	4	<u>15.17</u>
RAC131028350	35-28-35	4	<u>15.51</u>
RAC131022420	42-22-42	4	<u>19.84</u>
RAC131028420	42-28-42	4	<u>20.62</u>
RAC131035420	42-35-42	2	<u>20.96</u>
RAC131022540	54-22-54	1	<u>23.19</u>
RAC131028540	54-28-54	1	<u>23.74</u>
RAC131035540	54-35-54	1	<u>24.45</u>
RAC131042540	54-42-54	1	<u>25.90</u>
RAC131022760	76-22-76	1	<u>77.77</u>
RAC131028760	76-28-76	1	<u>78.28</u>
RAC131035760	76-35-76	1	<u>78.79</u>
RAC131042760	76-42-76	1	<u>79.45</u>
RAC131054760	76-54-76	1	<u>80.12</u>
RAC131054890	89-54-89	1	<u>116.22</u>
RAC131076890	89-76-89	1	<u>117.52</u>
RAC131761080	108-76-108	1	<u>141.06</u>
RAC131891080	108-89-108	1	<u>141.89</u>

RAC 246



IT: Manicotto ridotto
FR: Manchon réduit

Codice	Misura	Box	€
RAC246015180	15-18	10	<u>2.10</u>
RAC246015220	15-22	10	<u>2.61</u>
RAC246015280	15-28	10	<u>3.91</u>
RAC246018220	18-22	10	<u>2.70</u>
RAC246018280	18-28	10	<u>3.98</u>
RAC246022280	22-28	10	<u>3.03</u>
RAC246022350	22-35	10	<u>5.37</u>
RAC246022420	22-42	4	<u>10.03</u>
RAC246028350	28-35	4	<u>4.35</u>
RAC246028420	28-42	4	<u>10.22</u>
RAC246028540	28-54	2	<u>24.44</u>
RAC246035420	35-42	4	<u>7.33</u>
RAC246035540	35-54	2	<u>16.78</u>
RAC246042540	42-54	2	<u>11.89</u>
RAC246042760	42-76	1	<u>49.89</u>
RAC246054760	54-76	1	<u>46.80</u>
RAC246054890	54-89	1	<u>52.24</u>
RAC246076890	76-89	1	<u>53.10</u>
RAC246076108	76-108	1	<u>70.51</u>
RAC246089108	89-108	1	<u>81.83</u>

RAC 85

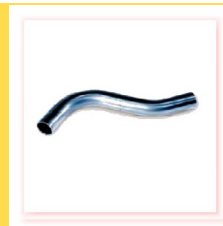

IT: Scavalcamento
FR: By-Pass

Codice	Misura	Box	€
RAC008500150	15	10	<u>3.82</u>
RAC008500180	18	10	<u>4.13</u>
RAC008500220	22	10	<u>4.68</u>
RAC008500280	28	4	<u>5.65</u>

RAX EPDM



IT: Guarnizione in EPDM nera
FR: EPDM Noir Joint torique

Codice	Misura	Box	€
RAXOREPDM015	15	1	<u>0.87</u>
RAXOREPDM018	18	1	<u>0.95</u>
RAXOREPDM022	22	1	<u>0.95</u>
RAXOREPDM028	28	1	<u>1.08</u>
RAXOREPDM035	35	1	<u>1.65</u>
RAXOREPDM042	42	1	<u>1.73</u>
RAXOREPDM054	54	1	<u>2.04</u>
RAXOREPDM076	76	1	<u>3.77</u>
RAXOREPDM089	89	1	<u>4.51</u>
RAXOREPDM108	108	1	<u>8.50</u>

RAX FPM



IT: Guarnizione in FPM verde (HT)
FR: FPM Vert Joint torique (HT)

Codice	Misura	Box	€
RAXORFPMV015	15	1	<u>1.39</u>
RAXORFPMV018	18	1	<u>1.60</u>
RAXORFPMV022	22	1	<u>1.78</u>
RAXORFPMV028	28	1	<u>2.04</u>
RAXORFPMV035	35	1	<u>2.56</u>
RAXORFPMV042	42	1	<u>3.34</u>
RAXORFPMV054	54	1	<u>3.90</u>
RAXORFPMV076	76	1	<u>7.76</u>
RAXORFPMV089	89	1	<u>11.62</u>
RAXORFPMV108	108	1	<u>25.71</u>

RAC 290



IT: Tappo a pressare
FR: Bouchon à sertir

Codice	Misura	Box	€
RAC2900000150	15	1	<u>4.25</u>
RAC2900000180	18	1	<u>4.53</u>
RAC2900000220	22	1	<u>4.87</u>
RAC2900000280	28	1	<u>7.11</u>
RAC2900000350	35	1	<u>10.13</u>
RAC2900000420	42	1	<u>16.33</u>
RAC2900000540	54	1	<u>17.78</u>
RAC2900000760	76	1	<u>36.97</u>
RAC2900000890	89	1	<u>45.14</u>
RAC2900001080	108	1	<u>65.60</u>

IT: Raccordi a pressare in acciaio inox AISI 316L (IPI-RAX)

FR: Raccords acier inox AISI 316L à sertir (IPI-RAX)

Profilo di Pressatura: "M" - Profile de sertissage: "M"

RAX 270



IT: Manicotto con battuta a pressare
FR: Manchon à sertir

Codice	Misura	Box	€
RAX270000150	15	25	4.77
RAX270000180	18	25	5.16
RAX270000220	22	25	6.16
RAX270000280	28	10	7.46
RAX270000350	35	10	8.67
RAX270000420	42	10	11.23
RAX270000540	54	5	14.18
RAX270000760	76	1	73.05
RAX270000890	89	1	86.19
RAX270001080	108	1	108.34

RAX 271



IT: Raccordo diritto maschio
FR: Manchon à sertir male

Codice	Misura	Box	€
RAX271005150	1/2"-15	10	10.36
RAX271005180	1/2"-18	10	10.40
RAX271005220	1/2"-22	10	11.53
RAX271007180	3/4"-18	10	11.10
RAX271007220	3/4"-22	10	11.75
RAX271007280	3/4"-28	10	14.78
RAX271010220	1"-22	10	15.17
RAX271010280	1"-28	10	14.91
RAX271010350	1"-35	10	19.47
RAX271012350	1"1/4-35	10	21.81
RAX271015420	1"1/2-42	10	31.82
RAX271020540	2"-54	5	42.70
RAX271025760	2"1/2-76	1	198.17
RAX271030890	3"-89	1	297.32
RAX271040108	4"-108	1	376.82

RAX 280



IT: Raccordo diritto femmina
FR: Manchon à sertir femelle

Codice	Misura	Box	€
RAX280005150	1/2"-15	10	10.14
RAX280005180	1/2"-18	10	10.93
RAX280005220	1/2"-22	10	12.05
RAX280007180	3/4"-18	10	11.75
RAX280007220	3/4"-22	10	13.48
RAX280007280	3/4"-28	10	15.09
RAX280010220	1"-22	10	15.82
RAX280010280	1"-28	10	20.94
RAX280012350	1"1/4-35	10	22.89
RAX280015420	1"1/2-42	10	37.07
RAX280020540	2"-54	5	52.72

RAX 270L



IT: Manicotto di riparazione
FR: Manchon reparation à sertir

Codice	Misura	Box	€
RAX270L00150	15	10	15.00
RAX270L00180	18	10	15.13
RAX270L00220	22	10	15.39
RAX270L00280	28	10	23.54
RAX270L00350	35	10	23.11
RAX270L00420	42	4	24.71
RAX270L00540	54	4	27.36
RAX270L00760	76	1	177.06
RAX270L00890	89	1	202.64
RAX270L01080	108	1	229.73

RAX 90



IT: Curva a pressare femmina
FR: Coude à sertir

Codice	Misura	Box	€
RAX090000150	15	25	6.68
RAX090000180	18	25	8.15
RAX090000220	22	15	9.32
RAX090000280	28	5	11.79
RAX090000350	35	5	18.51
RAX090000420	42	5	34.03
RAX090000540	54	3	46.48
RAX090000760	76	1	117.79
RAX090000890	89	1	168.39
RAX090001080	108	1	226.61

RAX 92



IT: Curva a pressare M/F
FR: Coude à sertir M/F

Codice	Misura	Box	€
RAX092000150	15	25	6.68
RAX092000180	18	25	8.15
RAX092000220	22	15	9.32
RAX092000280	28	5	11.79
RAX092000350	35	5	18.51
RAX092000420	42	5	34.03
RAX092000540	54	3	46.48
RAX092000760	76	1	117.79
RAX092000890	89	1	168.39
RAX092001080	108	1	226.61

IT: Raccordi a pressione in acciaio inox AISI 316L (IPI-RAX)

FR: Raccords acier inox AISI 316L à sertir (IPI-RAX)

Profilo di Pressatura: "M" - Profile de sertissage: "M"

RAX 120



IT: Curva a pressione a 45° femmina
FR: Coude 45° à sertir

Codice	Misura	Box	€
RAX120000150	15	25	<u>9.28</u>
RAX120000180	18	25	<u>9.93</u>
RAX120000220	22	25	<u>11.58</u>
RAX120000280	28	10	<u>13.44</u>
RAX120000350	35	10	<u>17.30</u>
RAX120000420	42	10	<u>27.88</u>
RAX120000540	54	5	<u>36.20</u>
RAX120000760	76	1	<u>112.29</u>
RAX120000890	89	1	<u>162.58</u>
RAX120001080	108	1	<u>217.77</u>

RAX 121



IT: Curva a pressione a 45° M/F
FR: Coude 45° à sertir M/F

Codice	Misura	Box	€
RAX121000150	15	25	<u>9.28</u>
RAX121000180	18	25	<u>9.93</u>
RAX121000220	22	25	<u>11.58</u>
RAX121000280	28	10	<u>13.44</u>
RAX121000350	35	10	<u>17.30</u>
RAX121000420	42	10	<u>27.88</u>
RAX121000540	54	5	<u>36.20</u>
RAX121000760	76	1	<u>112.29</u>
RAX121000890	89	1	<u>162.58</u>
RAX121001080	108	1	<u>217.77</u>

RAX 261



IT: Gomito a pressione filetto maschio
FR: Coude à sertir male

Codice	Misura	Box	€
RAX261005150	1/2"-15	15	<u>15.82</u>
RAX261005180	1/2"-18	15	<u>16.78</u>
RAX261007220	3/4"-22	10	<u>21.07</u>
RAX261010280	1"-28	10	<u>27.53</u>
RAX261012350	1 1/4"-35	10	<u>34.38</u>
RAX261015420	1 1/2"-42	10	<u>60.78</u>
RAX261020540	2"-54	5	<u>77.08</u>

RAX 262



IT: Gomito a pressione filetto femmina
FR: Coude à sertir femelle

Codice	Misura	Box	€
RAX262005150	1/2"-15	15	<u>17.12</u>
RAX262005180	1/2"-18	15	<u>18.30</u>
RAX262007220	3/4"-22	15	<u>22.54</u>
RAX262010280	1"-28	10	<u>30.61</u>
RAX262012350	1 1/4"-35	10	<u>43.01</u>

RAX 290



IT: Tappo a pressione
FR: Bouchon à sertir

Codice	Misura	Box	€
RAX290000150	15	10	<u>10.58</u>
RAX290000180	18	10	<u>11.88</u>
RAX290000220	22	10	<u>13.18</u>
RAX290000280	28	5	<u>15.39</u>
RAX290000350	35	5	<u>18.47</u>
RAX290000420	42	5	<u>24.02</u>
RAX290000540	54	3	<u>28.92</u>
RAX290000760	76	1	<u>58.83</u>
RAX290000890	89	1	<u>70.97</u>
RAX290001080	108	1	<u>77.69</u>

RAX 227



IT: Flangia con raccordo a pressione
FR: Raccord à bride

Codice	Misura	Box	€
RAX227000220	22	1	<u>64.90</u>
RAX227000280	28	1	<u>76.87</u>
RAX227000350	35	1	<u>116.80</u>
RAX227000420	42	1	<u>138.91</u>
RAX227000540	54	1	<u>176.54</u>
RAX227000760	76	1	<u>232.81</u>
RAX227000890	89	1	<u>281.50</u>
RAX227001080	108	1	<u>334.78</u>

IT: Raccordi a pressione in acciaio inox AISI 316L (IPI-RAX)

FR: Raccords acier inox AISI 316L à sertir (IPI-RAX)

Profilo di Pressatura: "M" - Profile de sertissage: "M"

RAX 130



IT: Tee a pressione
FR: Tee à sertir

Codice	Misura	Box	€
RAX130000150	15	10	<u>12.10</u>
RAX130000180	18	10	<u>12.44</u>
RAX130000220	22	10	<u>14.26</u>
RAX130000280	28	4	<u>16.78</u>
RAX130000350	35	4	<u>22.76</u>
RAX130000420	42	2	<u>31.78</u>
RAX130000540	54	2	<u>37.15</u>
RAX130000760	76	1	<u>200.99</u>
RAX130000890	89	1	<u>219.89</u>
RAX130001080	108	1	<u>271.44</u>

RAX 130F



IT: Tee uscita filetto femmina
FR: Tee à sertir femelle

Codice	Misura	Box	€
RAX130F05150	15-1/2"-15	10	<u>14.74</u>
RAX130F05180	18-1/2"-18	10	<u>15.35</u>
RAX130F05220	22-1/2"-22	10	<u>15.91</u>
RAX130F05280	28-1/2"-28	10	<u>18.25</u>
RAX130F05350	35-1/2"-35	5	<u>20.98</u>
RAX130F05420	42-1/2"-42	5	<u>25.54</u>
RAX130F05540	54-1/2"-54	3	<u>28.87</u>
RAX130F07280	28-3/4"-28	10	<u>22.07</u>
RAX130F07350	35-3/4"-35	5	<u>29.13</u>
RAX130F07420	42-3/4"-42	5	<u>32.95</u>
RAX130F07540	54-3/4"-54	3	<u>41.27</u>
RAX130F20540	54-2"-54	3	<u>81.72</u>
RAX130F20760	76-2"-76	1	<u>268.75</u>
RAX130F20890	89-2"-89	1	<u>280.67</u>
RAX130F20108	108-2"-108	1	<u>371.54</u>

RAX 246



IT: Manicotto ridotto
FR: Manchon réduit

Codice	Misura	Box	€
RAX246015220	15-22	25	<u>6.11</u>
RAX246015280	15-28	10	<u>6.98</u>
RAX246018220	18-22	10	<u>6.50</u>
RAX246018280	18-28	10	<u>7.11</u>
RAX246022280	22-28	10	<u>7.20</u>
RAX246022350	22-35	10	<u>10.06</u>
RAX246022420	22-42	10	<u>19.64</u>
RAX246028350	28-35	10	<u>11.10</u>
RAX246028420	28-42	10	<u>20.16</u>
RAX246028540	28-54	10	<u>33.12</u>
RAX246035420	35-42	10	<u>12.18</u>
RAX246035540	35-54	10	<u>23.32</u>
RAX246042540	42-54	10	<u>13.40</u>
RAX246054760	54-76	1	<u>65.16</u>
RAX246054890	54-89	1	<u>88.14</u>
RAX246076890	76-89	1	<u>120.26</u>
RAX246054108	54-108	1	<u>124.56</u>
RAX246076108	76-108	1	<u>132.71</u>
RAX246089108	89-108	1	<u>137.17</u>

RAX 131



IT: Tee a pressione ridotto
FR: Tee à sertir réduit

Codice	Misura	Box	€
RAX131015180	18-15-18	15	<u>14.09</u>
RAX131015220	22-15-22	15	<u>13.66</u>
RAX131015280	28-15-28	15	<u>14.13</u>
RAX131018220	22-18-22	15	<u>14.18</u>
RAX131018280	28-18-28	5	<u>15.04</u>
RAX131022280	28-22-28	5	<u>15.82</u>
RAX131022350	35-22-35	5	<u>19.08</u>
RAX131022420	42-22-42	5	<u>29.91</u>
RAX131022540	54-22-54	5	<u>36.11</u>
RAX131028350	35-28-35	5	<u>19.86</u>
RAX131028420	42-28-42	5	<u>31.08</u>
RAX131028540	54-28-54	4	<u>36.94</u>
RAX131035420	42-35-42	5	<u>32.21</u>
RAX131035540	54-35-54	4	<u>38.63</u>
RAX131042540	54-42-54	4	<u>40.32</u>
RAX131035760	76-35-76	1	<u>176.67</u>
RAX131042760	76-42-76	1	<u>190.58</u>
RAX131054760	76-54-76	1	<u>203.63</u>
RAX131042890	89-42-89	1	<u>294.89</u>
RAX131054890	89-54-89	1	<u>210.35</u>
RAX131076890	89-76-89	1	<u>223.01</u>
RAX131042108	108-42-108	1	<u>330.88</u>
RAX131054108	108-54-108	1	<u>267.10</u>
RAX131076108	108-76-108	1	<u>300.92</u>
RAX131089108	108-89-108	1	<u>308.16</u>

RAX 340



IT: Raccordo diritto 3 pezzi femmina
FR: Union 3 pièces droit femelle

Codice	Misura	Box	€
RAX340007220	3/4"-22	5	<u>42.79</u>
RAX340010280	1"-28	4	<u>53.80</u>
RAX340012350	1 1/4"-35	4	<u>69.76</u>
RAX340015420	1 1/2"-42	2	<u>82.98</u>
RAX340020540	2"-54	1	<u>154.25</u>

RAX 341



IT: Raccordo diritto 3 pezzi maschio
FR: Union 3 pièces droit male

Codice	Misura	Box	€
RAX341005150	1/2"-15	10	<u>29.18</u>
RAX341005180	1/2"-18	10	<u>32.13</u>
RAX341007220	3/4"-22	5	<u>34.25</u>
RAX341010280	1"-28	4	<u>57.57</u>
RAX341012350	1 1/4"-35	4	<u>73.36</u>
RAX341015420	1 1/2"-42	2	<u>92.26</u>
RAX341020540	2"-54	1	<u>146.62</u>

IT: Raccordi a pressione in acciaio inox AISI 316L (IPI-RAX)

FR: Raccords acier inox AISI 316L à sertir (IPI-RAX)

Profilo di Pressatura: "M" - Profile de sertissage: "M"

RAX 263



IT: Curva con base
FR: Coude applique

Codice	Misura	Box	€
<u>RAX263005150</u>	<u>1/2"-15</u>	<u>10</u>	<u>16.43</u>
<u>RAX263005180</u>	<u>1/2"-18</u>	<u>10</u>	<u>17.65</u>
<u>RAX263007220</u>	<u>3/4"-22</u>	<u>10</u>	<u>24.71</u>

RAX 85



IT: Scavalcamento
FR: By-pass

Codice	Misura	Box	€
<u>RAX08500150</u>	<u>15</u>	<u>10</u>	<u>8.84</u>
<u>RAX08500180</u>	<u>18</u>	<u>10</u>	<u>9.45</u>
<u>RAX08500220</u>	<u>22</u>	<u>10</u>	<u>10.97</u>
<u>RAX08500280</u>	<u>28</u>	<u>4</u>	<u>12.66</u>

RAX 280G



IT: Manicotto c/dado girevole
FR: Manchon écrou tournant

Codice	Misura	Box	€
<u>RAX280G07150</u>	<u>3/4"-15</u>	<u>25</u>	<u>21.56</u>
<u>RAX280G07180</u>	<u>3/4"-18</u>	<u>10</u>	<u>23.76</u>
<u>RAX280G10220</u>	<u>1"-22</u>	<u>5</u>	<u>31.64</u>
<u>RAX280G12280</u>	<u>1"1/4-28</u>	<u>2</u>	<u>38.88</u>
<u>RAX280G15350</u>	<u>1"1/2-35</u>	<u>2</u>	<u>60.88</u>

IT: Raccordi a pressare in rame per acqua/gas (IPR-RR)

FR: Raccords cuivre à sertir eau/gaz (IPR-RR)

Profilo di Pressatura: "M" - Profile de sertissage: "M"

RRP 270M



IT: Manicotto con battuta a pressare
FR: Manchon à sertir

Codice	Misura	Box	€
<u>RRP27000015M</u>	<u>15</u>	<u>10</u>	<u>3.18</u>
<u>RRP27000018M</u>	<u>18</u>	<u>10</u>	<u>3.84</u>
<u>RRP27000022M</u>	<u>22</u>	<u>10</u>	<u>4.38</u>
<u>RRP27000028M</u>	<u>28</u>	<u>10</u>	<u>8.53</u>

RRP 271M



IT: Raccordo diretto maschio
FR: Manchon à sertir male

Codice	Misura	Box	€
<u>RRP27100515M</u>	<u>1/2"-15</u>	<u>10</u>	<u>4.09</u>
<u>RRP27100522M</u>	<u>1/2"-22</u>	<u>10</u>	<u>6.64</u>
<u>RRP27100718M</u>	<u>3/4"-18</u>	<u>10</u>	<u>6.89</u>
<u>RRP27100722M</u>	<u>3/4"-22</u>	<u>10</u>	<u>6.15</u>
<u>RRP27100728M</u>	<u>3/4"-28</u>	<u>10</u>	<u>19.79</u>
<u>RRP27101022M</u>	<u>1"-22</u>	<u>5</u>	<u>10.78</u>
<u>RRP27101028M</u>	<u>1"-28</u>	<u>5</u>	<u>10.83</u>

RRP 280M



IT: Raccordo diretto femmina
FR: Manchon à sertir femelle

Codice	Misura	Box	€
<u>RRP28000515M</u>	<u>1/2"-15</u>	<u>10</u>	<u>4.43</u>
<u>RRP28000522M</u>	<u>1/2"-22</u>	<u>10</u>	<u>6.89</u>
<u>RRP28000718M</u>	<u>3/4"-18</u>	<u>10</u>	<u>10.33</u>
<u>RRP28000722M</u>	<u>3/4"-22</u>	<u>10</u>	<u>6.89</u>
<u>RRP28001028M</u>	<u>1"-28</u>	<u>5</u>	<u>11.58</u>
<u>RRP28001235M</u>	<u>1"1/4-35</u>	<u>5</u>	<u>26.81</u>

RRP 90M



IT: Curva a pressare femmina
FR: Coude à sertir

Codice	Misura	Box	€
<u>RRP09000015M</u>	<u>15</u>	<u>10</u>	<u>3.56</u>
<u>RRP09000018M</u>	<u>18</u>	<u>10</u>	<u>5.02</u>
<u>RRP09000022M</u>	<u>22</u>	<u>10</u>	<u>5.85</u>
<u>RRP09000028M</u>	<u>28</u>	<u>5</u>	<u>11.13</u>
<u>RRP09000035M</u>	<u>35</u>	<u>5</u>	<u>21.97</u>

RRP 92M



IT: Curva a pressare M/F
FR: Coude à sertir M/F

Codice	Misura	Box	€
<u>RRP09200015M</u>	<u>15</u>	<u>10</u>	<u>3.56</u>
<u>RRP09200018M</u>	<u>18</u>	<u>10</u>	<u>5.02</u>
<u>RRP09200022M</u>	<u>22</u>	<u>10</u>	<u>5.85</u>
<u>RRP09200028M</u>	<u>28</u>	<u>5</u>	<u>11.13</u>
<u>RRP09200035M</u>	<u>35</u>	<u>5</u>	<u>21.97</u>

RRP 120M



IT: Curva a pressare a 45° femmina
FR: Coude 45° à sertir

Codice	Misura	Box	€
<u>RRP12000015M</u>	<u>15</u>	<u>10</u>	<u>3.58</u>
<u>RRP12000018M</u>	<u>18</u>	<u>10</u>	<u>5.07</u>
<u>RRP12000022M</u>	<u>22</u>	<u>10</u>	<u>5.70</u>
<u>RRP12000028M</u>	<u>28</u>	<u>5</u>	<u>14.72</u>
<u>RRP12000035M</u>	<u>35</u>	<u>5</u>	<u>21.18</u>

IT: Raccordi a pressione in rame per acqua/gas (IPR-RR)

FR: Raccords cuivre à sertir eau/gaz (IPR-RR)

Profilo di Pressatura: "M" - Profile de sertissage: "M"

RRP 122M



IT: Curva a pressione a 45° M/F
FR: Coude 45° à sertir M/F

Codice	Misura	Box	€
RRP122000015M	15	10	<u>3.58</u>
RRP122000018M	18	10	<u>5.07</u>
RRP122000022M	22	10	<u>5.70</u>
RRP122000028M	28	5	<u>14.72</u>
RRP122000035M	35	5	<u>21.18</u>

RRP 130M



IT: Tee a pressione
FR: Tee à sertir

Codice	Misura	Box	€
RRP130000015M	15	10	<u>6.47</u>
RRP130000018M	18	10	<u>10.01</u>
RRP130000022M	22	10	<u>10.43</u>
RRP130000028M	28	5	<u>16.77</u>
RRP130000035M	35	5	<u>30.92</u>

RRP 131M



IT: Tee a pressione ridotto
FR: Tee à sertir réduit

Codice	Misura	Box	€
RRP13100BABM	18-15-18	10	<u>8.80</u>
RRP13100CACM	22-15-22	10	<u>10.01</u>
RRP13100DADM	28-15-28	5	<u>17.30</u>
RRP13100DBDM	28-18-28	5	<u>20.68</u>
RRP13100DCDM	28-22-28	5	<u>18.53</u>
RRP13100ECEM	35-22-35	5	<u>26.95</u>
RRP13100EDEM	35-28-35	5	<u>31.27</u>

RRP 130FM



IT: Tee uscita filetto femmina
FR: Tee à sertir femelle

Codice	Misura	Box	€
RRP130F0515M	1/2"-15	10	<u>13.79</u>
RRP130F0522M	1/2"-22	10	<u>18.71</u>
RRP130F0528M	1/2"-28	5	<u>23.61</u>
RRP130F0535M	1/2"-35	5	<u>33.45</u>
RRP130F0722M	3/4"-22	5	<u>27.57</u>
RRP130F0728M	3/4"-28	5	<u>31.26</u>

RRP 246M



IT: Manicotto ridotto
FR: Manchon réduit

Codice	Misura	Box	€
RRP24601815M	18-15	10	<u>3.41</u>
RRP24602215M	22-15	10	<u>3.35</u>
RRP24602218M	22-18	10	<u>3.56</u>
RRP24602815M	28-15	10	<u>8.27</u>
RRP24602818M	28-18	10	<u>8.53</u>
RRP24602822M	28-22	10	<u>8.80</u>
RRP24603522M	35-22	10	<u>10.84</u>
RRP24603528M	35-28	10	<u>11.36</u>

RRP 290M



IT: Tappo a pressione
FR: Bouchon à sertir

Codice	Misura	Box	€
RRP29000018M	18	10	<u>9.38</u>
RRP29000022M	22	10	<u>10.61</u>
RRP29000028M	28	5	<u>15.82</u>

IT: Raccordi a pressare per tubazioni multistrato (IPM-MU)

FR: Raccords laiton à sertir pour tube multicouche (IPM-MU)

Multiprofilo di Pressatura: "TH—H—U" - Multi Profile de sertissage: "TH—H—U"

MU 870



IT: Manicotto a pressare
FR: Manchon à sertir

Codice	Misura	Box	€
MU0870000160	16	10	<u>4.45</u>
MU0870000200	20	10	<u>5.11</u>
MU0870000260	26	10	<u>8.26</u>
MU0870000320	32	10	<u>12.14</u>
MU0870000400	40	5	<u>30.36</u>
MU0870000500	50	5	<u>47.16</u>
MU0870000630	63	1	<u>74.58</u>

MU 871



IT: Raccordo diretto maschio
FR: Manchon à sertir male

Codice	Misura	Box	€
MU0871005160	1/2"-16	10	<u>3.07</u>
MU0871005200	1/2"-20	10	<u>3.88</u>
MU0871007200	3/4"-20	10	<u>4.99</u>
MU0871007260	3/4"-26	5	<u>6.25</u>
MU0871010260	1"-26	5	<u>7.76</u>
MU0871010320	1"-32	5	<u>9.15</u>
MU0871012400	1 1/4-40	1	<u>27.71</u>
MU0871015500	1 1/2-50	1	<u>40.17</u>
MU0871020630	2"-63	1	<u>63.26</u>

MU 880



IT: Raccordo diretto femmina
FR: Manchon à sertir femelle

Codice	Misura	Box	€
MU0880005160	1/2"-16	10	<u>3.60</u>
MU0880005200	1/2"-20	10	<u>4.54</u>
MU0880007200	3/4"-20	10	<u>5.44</u>
MU0880007260	3/4"-26	5	<u>6.78</u>
MU0880010320	1"-32	5	<u>10.42</u>
MU0880012400	1 1/4-40	1	<u>26.44</u>
MU0880015500	1 1/2-50	1	<u>35.43</u>
MU0880020630	2"-63	1	<u>60.44</u>

MU 860



IT: Curva a pressare femmina
FR: Coude à sertir

Codice	Misura	Box	€
MU0860000160	16	10	<u>5.31</u>
MU0860000200	20	10	<u>7.07</u>
MU0860000260	26	10	<u>11.44</u>
MU0860000320	32	10	<u>16.31</u>
MU0860000400	40	5	<u>38.46</u>
MU0860000500	50	5	<u>63.96</u>
MU0860000630	63	1	<u>104.58</u>

MU 861



IT: Gomito a pressare filetto maschio
FR: Coude à sertir male

Codice	Misura	Box	€
MU0861005160	1/2"-16	10	<u>4.82</u>
MU0861005200	1/2"-20	10	<u>5.84</u>
MU0861007200	3/4"-20	10	<u>7.32</u>
MU0861007260	3/4"-26	5	<u>9.24</u>
MU0861010320	1"-32	5	<u>14.63</u>
MU0861012400	1 1/4-40	1	<u>35.47</u>
MU0861015500	1 1/2-50	1	<u>64.98</u>
MU0861020630	2"-63	1	<u>100.25</u>

MU 862



IT: Gomito a pressare filetto femmina
FR: Coude à sertir femelle

Codice	Misura	Box	€
MU0862005160	1/2"-16	10	<u>4.29</u>
MU0862005200	1/2"-20	10	<u>5.72</u>
MU0862007200	3/4"-20	10	<u>6.70</u>
MU0862007260	3/4"-26	5	<u>9.48</u>
MU0862010320	1"-32	5	<u>14.92</u>
MU0862012400	1 1/4-40	1	<u>38.82</u>
MU0862015500	1 1/2-50	1	<u>59.42</u>

IT: Raccordi a pressare per tubazioni multistrato (IPM-MU)

FR: Raccords laiton à sertir pour tube multicouche (IPM-MU)

Multiprofilo di Pressatura: "TH—H—U" - Multi Profile de sertissage: "TH—H—U"

MU 850



IT: Tee a pressare
FR: Tee à sertir

Codice	Misura	Box	€
MU0850000160	16	10	7.03
MU0850000200	20	10	9.44
MU0850000260	26	5	17.21
MU0850000320	32	5	25.54
MU0850000400	40	3	51.45
MU0850000500	50	2	85.04
MU0850000630	63	1	126.03

MU 851



IT: Tee a pressare maschio
FR: Tee à sertir male

Codice	Misura	Box	€
MU0851005160	16-1/2"-16	10	7.40
MU0851005200	20-1/2"-20	10	9.11
MU0851007200	20-3/4"-20	10	10.87
MU0851007260	26-3/4"-26	5	14.59
MU0851010260	26-1"-26	5	19.17
MU0871010320	32-1"-32	3	21.33

MU 852



IT: Tee a pressare femmina
FR: Tee à sertir femelle

Codice	Misura	Box	€
MU0852005160	16-1/2"-16	10	6.87
MU0852005200	20-1/2"-20	10	9.03
MU0852007200	20-3/4"-20	10	10.63
MU0852007260	26-3/4"-26	5	14.51
MU0852010260	26-1"-26	5	23.38
MU0852010320	32-1"-32	3	21.70
MU0852012400	40-1"1/4-40	2	52.39
MU0852015500	50-1"1/2-50	2	86.97

MU 853



IT: Tee a pressare ridotto
FR: Tee à sertir réduit

Codice	Misura	Box	€
MU085300BAB0	20-16-20	10	9.32
MU085300DAD0	26-16-26	10	18.10
MU085300EAE0	32-16-32	10	26.44
MU085300BAA0	20-16-16	10	9.56
MU085300DBB0	26-20-20	10	18.27
MU085300DBD0	26-20-26	10	18.19
MU085300DDB0	26-26-20	10	18.35
MU085300EBE0	32-20-32	5	26.52
MU085300EDD0	32-26-26	5	28.03
MU085300EDE0	32-26-32	5	26.97
MU085300FDF0	40-26-40	5	45.20
MU085300FEF0	40-32-40	5	48.43
MU085300FEE0	40-32-32	5	46.26
MU085300GDG0	50-26-50	5	75.77
MU085300GEG0	50-32-50	5	76.67
MU085300GFG0	50-40-50	5	80.06

MU 870R



IT: Manicotto ridotto
FR: Manchon réduit

Codice	Misura	Box	€
MU0870R00BA0	16-20	10	5.03
MU0870R00DA0	16-26	10	6.99
MU0870R00EA0	16-32	10	8.17
MU0870R00DB0	20-26	10	6.95
MU0870R00EC0	20-32	10	10.09
MU0870R00ED0	26-32	10	11.20
MU0870R00FD0	26-40	5	28.53
MU0870R00FE0	32-40	5	28.53
MU0870R00GE0	32-50	5	42.87
MU0870R00GF0	40-50	5	43.32
MU0870R00HF0	40-63	2	62.98
MU0870R00HG0	50-63	2	68.13

MU 863



IT: Curva con base a pressare
FR: Applique à sertir femelle

Codice	Misura	Box	€
MU0863005160	1/2"-16	10	6.58
MU0863005200	1/2"-20	10	7.27
MU0863007260	3/4"-26	10	12.30

IT: Raccordi a pressare per tubazioni multistrato (IPM-MU)

FR: Raccords laiton à sertir pour tube multicouche (IPM-MU)

Multiprofilo di Pressatura: "TH—H—U" - Multi Profile de sertissage: "TH—H—U"

MU 881 News



IT: Raccordo diritto con dado girevole sede piana
FR: Mamelon femelle écrou tournant portée plate

Codice	Misura	Box	€
MU0881005160	1/2"-16	10	<u>4.33</u>
MU0881005200	1/2"-20	10	<u>5.84</u>
MU0881007160	3/4"-16	10	<u>6.42</u>
MU0881007200	3/4"-20	10	<u>7.27</u>
MU0881007260	3/4"-26	10	<u>17.00</u>

MU 882



IT: Raccordo gomito con dado girevole sede piana
FR: Coude femelle écrou tournant portée plate

Codice	Misura	Box	€
MU0882005160	1/2"-16	10	<u>12.22</u>
MU0882005200	1/2"-20	10	<u>12.91</u>

MU 120 News



IT: Curva 45° a pressare
FR: Coude 45° à sertir

Codice	Misura	Box	€
MU0120000320	32	10	<u>24.41</u>
MU0120000400	40	5	<u>52.76</u>
MU0120000500	50	1	<u>73.02</u>
MU0120000630	63	1	<u>113.07</u>

MU 600



IT: Valvola a sfera incasso a pressare
FR: Robinet à boisseau sphérique à sertir

Codice	Misura	Box	€
MU060000016N	16	5	<u>39.80</u>
MU060000020N	20	5	<u>49.16</u>

MU 830



IT: Kit collegamento utenza
FR: Kit double voie à sertir

Codice	Misura	Box	€
MU0830005160	16-20	2	<u>27.00</u>

MU 602 News



IT: Valvola sfera a pressare con calotta sede piana
FR: Robinet Boisseau équerre à sertir écrou tournant portée plate

Codice	Misura	Box	€
MU0602007200	3/4"-20	1	<u>20.45</u>
MU0602010260	1"-26	1	<u>28.73</u>

IT: Tubazioni per sistemi a pressare

FR: Tuyauterie pour systèmes à sertir

RAXTUBO



IT: Tubo INOX AISI 316L
FR: Tube Acier Inoxidabile AISI 316L

Codice	Misura	Box	€
<u>RAXTUB000150</u>	<u>15x1</u>	<u>6m</u>	
<u>RAXTUB000180</u>	<u>18x1</u>	<u>6m</u>	
<u>RAXTUB000220</u>	<u>22x1,2</u>	<u>6m</u>	
<u>RAXTUB000280</u>	<u>28x1,2</u>	<u>6m</u>	
<u>RAXTUB000350</u>	<u>35x1,5</u>	<u>6m</u>	
<u>RAXTUB000420</u>	<u>42x1,5</u>	<u>6m</u>	
<u>RAXTUB000540</u>	<u>54x1,5</u>	<u>6m</u>	
<u>RAXTUB000760</u>	<u>76x2</u>	<u>6m</u>	
<u>RAXTUB000890</u>	<u>89x2</u>	<u>6m</u>	
<u>RAXTUB001080</u>	<u>108x2</u>	<u>6m</u>	

RACTUBO



IT: Tubo Acciaio Carbonio zincato
FR: Tube Acier Carbon galvanizè

Codice	Misura	Box	€
<u>RACTUB000150</u>	<u>15x1,2</u>	<u>6m</u>	
<u>RACTUB000180</u>	<u>18x1,2</u>	<u>6m</u>	
<u>RACTUB000220</u>	<u>22x1,5</u>	<u>6m</u>	
<u>RACTUB000280</u>	<u>28x1,5</u>	<u>6m</u>	
<u>RACTUB000350</u>	<u>35x1,5</u>	<u>6m</u>	
<u>RACTUB000420</u>	<u>42x1,5</u>	<u>6m</u>	
<u>RACTUB000540</u>	<u>54x1,5</u>	<u>6m</u>	
<u>RACTUB000760</u>	<u>76x2</u>	<u>6m</u>	
<u>RACTUB000890</u>	<u>89x2</u>	<u>6m</u>	
<u>RACTUB001080</u>	<u>108x2</u>	<u>6m</u>	

TRAME

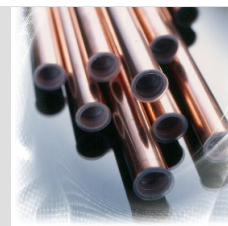

IT: Tubo Rame
FR: Tube de cuivre

Codice	Misura	Box	€
<u>TUBORAME15V</u>	<u>15</u>	<u>5m</u>	
<u>TUBORAME18V</u>	<u>18</u>	<u>5m</u>	
<u>TUBORAME22V</u>	<u>22</u>	<u>5m</u>	
<u>TUBORAME28V</u>	<u>28</u>	<u>5m</u>	
<u>TUBORAME35V</u>	<u>35</u>	<u>5m</u>	
<u>TUBORAME42V</u>	<u>42</u>	<u>5m</u>	
<u>TUBORAME54V</u>	<u>54</u>	<u>5m</u>	

TMULTI

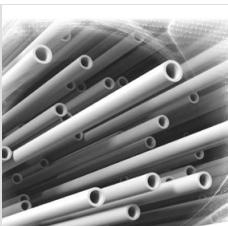

IT: Tubo multistrato in verga
FR: Tube Multicouche en barre

Codice	Misura	Box	€
<u>TUBOMULTV032</u>	<u>32X3</u>	<u>5m</u>	
<u>TUBOMULTV040</u>	<u>40X3,5</u>	<u>5m</u>	
<u>TUBOMULTV050</u>	<u>50X4</u>	<u>5m</u>	
<u>TUBOMULTV063</u>	<u>63X4,5</u>	<u>5m</u>	

TMULTI



IT: Tubo Multistrato nudo in rotolo
FR: Tube Multicouche en rouleau

Codice	Misura	Box	€
<u>TUBOMULT0016</u>	<u>16x2</u>	<u>100m</u>	
<u>TUBOMULTC016</u>	<u>16x2</u>	<u>500m</u>	
<u>TUBOMULT0020</u>	<u>20x2</u>	<u>100m</u>	
<u>TUBOMULT0026</u>	<u>26x3</u>	<u>50m</u>	
<u>TUBOMULT0032</u>	<u>32x3</u>	<u>50m</u>	

TMULTIKK

Sanitario e riscaldamento
Legge 10/91



IT: Tubo multistrato preisolato rosso
FR: Tube Multicouche isolè rouge

Codice	Misura	Box	€
<u>TUBOMULTKK16</u>	<u>16x2</u>	<u>50m</u>	
<u>TUBOMULTKK20</u>	<u>20x2</u>	<u>50m</u>	
<u>TUBOMULTKK26</u>	<u>26x3</u>	<u>50m</u>	
<u>TUBOMULTKK32</u>	<u>32x3</u>	<u>25m</u>	

TMULTIKX

Condizionamento
Spessore isolante maggiorato



IT: Tubo multistrato preisolato verde
FR: Tube Multicouche isolè vert

Codice	Misura	Box	€
<u>TUBOMULTKX16</u>	<u>16x2</u>	<u>50m</u>	
<u>TUBOMULTKX20</u>	<u>20x2</u>	<u>50m</u>	
<u>TUBOMULTKX26</u>	<u>26x3</u>	<u>50m</u>	
<u>TUBOMULTKX32</u>	<u>32x3</u>	<u>25m</u>	

TMULTIKK

Sanitario e riscaldamento
Legge 10/91



IT: Tubo multistrato preisolato blu
FR: Tube Multicouche isolè bleu

Codice	Misura	Box	€
<u>TUBOMULTKK16B</u>	<u>16x2</u>	<u>50m</u>	
<u>TUBOMULTKK20B</u>	<u>20x2</u>	<u>50m</u>	
<u>TUBOMULTKK26B</u>	<u>26x3</u>	<u>50m</u>	
<u>TUBOMULTKK32B</u>	<u>32x3</u>	<u>25m</u>	

Su tutte le tubazioni
Prezzi Netti Periodici

Sistemi a stringere



IT: Raccordi a stringere per tubazioni multistrato (MX)

FR: Raccords laiton à compression pour tube multicouche (MX)

MX 570



IT: Manicotto a stringere
FR: Manchon à compression

Codice	Misura	Box	€
<u>MX0570000160</u>	<u>16</u>	<u>10</u>	<u>4.99</u>
<u>MX0570000200</u>	<u>20</u>	<u>10</u>	<u>8.39</u>
<u>MX0570000260</u>	<u>26</u>	<u>5</u>	<u>12.54</u>
<u>MX0570000320</u>	<u>32</u>	<u>5</u>	<u>21.47</u>

MX 571



IT: Raccordo diretto maschio
FR: Manchon à compression male

Codice	Misura	Box	€
<u>MX0571005160</u>	<u>1/2"-16</u>	<u>10</u>	<u>2.85</u>
<u>MX0571005180</u>	<u>1/2"-18</u>	<u>10</u>	<u>5.12</u>
<u>MX0571005200</u>	<u>1/2"-20</u>	<u>10</u>	<u>4.82</u>
<u>MX0571007160</u>	<u>3/4"-16</u>	<u>10</u>	<u>4.11</u>
<u>MX0571007200</u>	<u>3/4"-20</u>	<u>10</u>	<u>4.91</u>
<u>MX0571007260</u>	<u>3/4"-26</u>	<u>10</u>	<u>8.35</u>
<u>MX0571010260</u>	<u>1"-26</u>	<u>10</u>	<u>8.60</u>
<u>MX0571010320</u>	<u>1"-32</u>	<u>10</u>	<u>13.04</u>

MX 580



IT: Raccordo diretto femmina
FR: Manchon à compression femelle

Codice	Misura	Box	€
<u>MX0580005160</u>	<u>1/2"-16</u>	<u>10</u>	<u>3.19</u>
<u>MX0580005200</u>	<u>1/2"-20</u>	<u>10</u>	<u>4.82</u>
<u>MX0580005260</u>	<u>1/2"-26</u>	<u>10</u>	<u>15.23</u>
<u>MX0580007160</u>	<u>3/4"-16</u>	<u>10</u>	<u>4.70</u>
<u>MX0580007200</u>	<u>3/4"-20</u>	<u>10</u>	<u>5.33</u>
<u>MX0580007260</u>	<u>3/4"-26</u>	<u>10</u>	<u>8.09</u>
<u>MX0580010260</u>	<u>1"-26</u>	<u>10</u>	<u>8.85</u>
<u>MX0580010320</u>	<u>1"-32</u>	<u>10</u>	<u>13.25</u>

MX 560



IT: Curva a stringere femmina
FR: Coude à compression

Codice	Misura	Box	€
<u>MX0560000160</u>	<u>16</u>	<u>10</u>	<u>5.75</u>
<u>MX0560000200</u>	<u>20</u>	<u>10</u>	<u>8.85</u>
<u>MX0560000260</u>	<u>26</u>	<u>5</u>	<u>13.63</u>
<u>MX0560000320</u>	<u>32</u>	<u>5</u>	<u>23.57</u>

MX 561



IT: Gomito a stringere maschio
FR: Coude à compression male

Codice	Misura	Box	€
<u>MX0561005160</u>	<u>1/2"-16</u>	<u>10</u>	<u>4.19</u>
<u>MX0561005200</u>	<u>1/2"-20</u>	<u>10</u>	<u>5.96</u>
<u>MX0561007200</u>	<u>3/4"-20</u>	<u>10</u>	<u>6.21</u>
<u>MX0561007260</u>	<u>3/4"-26</u>	<u>5</u>	<u>10.07</u>
<u>MX0561010260</u>	<u>1"-26</u>	<u>5</u>	<u>10.91</u>
<u>MX0561010320</u>	<u>1"-32</u>	<u>5</u>	<u>15.98</u>

MX 562



IT: Gomito a stringere femmina
FR: Coude à compression femelle

Codice	Misura	Box	€
<u>MX0562005160</u>	<u>1/2"-16</u>	<u>10</u>	<u>4.53</u>
<u>MX0562005200</u>	<u>1/2"-20</u>	<u>10</u>	<u>6.00</u>
<u>MX0562007200</u>	<u>3/4"-20</u>	<u>10</u>	<u>6.79</u>
<u>MX0562007260</u>	<u>3/4"-26</u>	<u>5</u>	<u>9.65</u>
<u>MX0562010260</u>	<u>1"-26</u>	<u>5</u>	<u>11.24</u>
<u>MX0562010320</u>	<u>1"-32</u>	<u>5</u>	<u>16.11</u>

IT: Raccordi a stringere per tubazioni multistrato (MX)

FR: Raccords laiton à compression pour tube multicouche (MX)

MX 550



IT: Tee a stringere
FR: Tee à compression

Codice	Misura	Box	€
<u>MX0550000160</u>	16	10	<u>8.01</u>
<u>MX0550000200</u>	20	10	<u>13.04</u>
<u>MX0550000260</u>	26	5	<u>20.93</u>
<u>MX0550000320</u>	32	5	<u>34.73</u>

MX 551



IT: Tee a stringere maschio
FR: Tee à compression male

Codice	Misura	Box	€
<u>MX0551005160</u>	16-1/2-16	10	<u>6.63</u>
<u>MX0551005200</u>	20-1/2-20	10	<u>10.19</u>
<u>MX0551007200</u>	20-3/4-20	10	<u>11.16</u>
<u>MX0551007260</u>	26-3/4-26	5	<u>16.94</u>
<u>MX0551010260</u>	26-1"-26	5	<u>19.63</u>
<u>MX0551010320</u>	32-1"-32	5	<u>30.41</u>

MX 552



IT: Tee a stringere femmina
FR: Tee à compression femelle

Codice	Misura	Box	€
<u>MX0552005160</u>	16-1/2-16	10	<u>6.71</u>
<u>MX0552005200</u>	20-1/2-20	10	<u>10.44</u>
<u>MX0552007200</u>	20-3/4-20	10	<u>10.82</u>
<u>MX0552007260</u>	26-3/4-26	5	<u>16.65</u>
<u>MX0552010260</u>	26-1"-26	5	<u>23.74</u>
<u>MX0552010320</u>	32-1"-32	5	<u>29.02</u>

MX 553



IT: Tee a stringere ridotto
FR: Tee réduit à compression

Codice	Misura	Box	€
<u>MX055300AAC0</u>	16-16-20	10	<u>12.25</u>
<u>MX055300ACC0</u>	16-20-20	10	<u>13.04</u>
<u>MX055300CAC0</u>	20-16-20	10	<u>13.04</u>
<u>MX055300DAD0</u>	26-16-26	5	<u>20.22</u>
<u>MX055300DCD0</u>	26-20-26	5	<u>20.51</u>
<u>MX055300EDE0</u>	32-26-32	5	<u>34.56</u>

MX 563



IT: Gomito a stringere con base
FR: Coude applique à compression

Codice	Misura	Box	€
<u>MX0563005160</u>	1/2"-16	10	<u>5.54</u>
<u>MX0563005200</u>	1/2"-20	10	<u>7.97</u>

MX 592



IT: Manicotto con dado girevole sede piana
FR: Manchon ecrou tournant protégé plate

Codice	Misura	Box	€
<u>MX0592005160</u>	1/2-16	10	<u>4.98</u>
<u>MX0592005200</u>	1/2-20	10	<u>6.23</u>
<u>MX0592007160</u>	3/4-16	10	<u>5.19</u>
<u>MX0592007200</u>	3/4-20	5	<u>6.43</u>
<u>MX0592007260</u>	3/4"-26	5	<u>9.34</u>
<u>MX0592010260</u>	1"-26	5	<u>9.75</u>

News

IT: Raccordi a stringere per tubazioni rame (RB)

FR: Raccords laiton à compression pour tube cuivre (RB)

RB 270



IT: Manicotto a stringere
FR: Manchon à compression

Codice	Misura	Box	€
<u>RB0270000120</u>	12	10	<u>3.33</u>
<u>RB0270000140</u>	14	10	<u>4.69</u>
<u>RB0270000150</u>	15	10	<u>5.80</u>
<u>RB0270000160</u>	16	10	<u>5.84</u>
<u>RB0270000180</u>	18	10	<u>6.20</u>
<u>RB0270000220</u>	22	10	<u>6.41</u>
<u>RB0270000280</u>	28	10	<u>10.31</u>
<u>RB0270000350</u>	35	5	<u>21.75</u>

RB 271



IT: Raccordo diretto maschio
FR: Manchon à compression male

Codice	Misura	Box	€
<u>RB0271003120</u>	3/8"-12	10	<u>2.51</u>
<u>RB0271003150</u>	3/8"-15	10	<u>2.94</u>
<u>RB0271005120</u>	1/2"-12	10	<u>3.12</u>
<u>RB0271005140</u>	1/2"-14	10	<u>3.71</u>
<u>RB0271005150</u>	1/2"-15	10	<u>3.24</u>
<u>RB0271005160</u>	1/2"-16	10	<u>4.43</u>
<u>RB0271005180</u>	1/2"-18	10	<u>4.88</u>
<u>RB0271007160</u>	3/4"-16	10	<u>5.41</u>
<u>RB0271007180</u>	3/4"-18	10	<u>5.63</u>
<u>RB0271007220</u>	3/4"-22	10	<u>5.49</u>
<u>RB0271010220</u>	1"-22	10	<u>6.84</u>
<u>RB0271010280</u>	1"-28	10	<u>8.51</u>
<u>RB0271012350</u>	1"1/4-35	5	<u>18.24</u>

RB 280



IT: Raccordo diretto femmina
FR: Manchon à compression femelle

Codice	Misura	Box	€
<u>RB0280003120</u>	3/8"-12	10	<u>2.80</u>
<u>RB0280003150</u>	3/8"-15	10	<u>4.69</u>
<u>RB0280005120</u>	1/2"-12	10	<u>4.65</u>
<u>RB0280005140</u>	1/2"-14	10	<u>4.59</u>
<u>RB0280005150</u>	1/2"-15	10	<u>3.57</u>
<u>RB0280005160</u>	1/2"-16	10	<u>4.80</u>
<u>RB0280005180</u>	1/2"-18	10	<u>5.33</u>
<u>RB0280007180</u>	3/4"-18	10	<u>7.63</u>
<u>RB0280007220</u>	3/4"-22	10	<u>6.04</u>
<u>RB0280010220</u>	1"-22	10	<u>9.41</u>
<u>RB0280010280</u>	1"-28	10	<u>10.51</u>
<u>RB0280012350</u>	1"1/4-35	5	<u>18.65</u>

RB 260



IT: Curva a stringere femmina
FR: Coude à compression

Codice	Misura	Box	€
<u>RB0260000120</u>	12	10	<u>4.12</u>
<u>RB0260000140</u>	14	10	<u>5.18</u>
<u>RB0260000150</u>	15	10	<u>5.65</u>
<u>RB0260000160</u>	16	10	<u>6.98</u>
<u>RB0260000180</u>	18	10	<u>7.45</u>
<u>RB0260000220</u>	22	10	<u>7.57</u>
<u>RB0260000280</u>	28	10	<u>12.26</u>
<u>RB0260000350</u>	35	5	<u>24.49</u>

RB 261



IT: Gomito a stringere maschio
FR: Coude à compression male

Codice	Misura	Box	€
<u>RB0261003120</u>	3/8"-12	10	<u>3.65</u>
<u>RB0261005120</u>	1/2"-12	10	<u>5.14</u>
<u>RB0261005140</u>	1/2"-14	10	<u>4.53</u>
<u>RB0261005150</u>	1/2"-15	10	<u>5.24</u>
<u>RB0261005160</u>	1/2"-16	10	<u>5.02</u>
<u>RB0261007180</u>	3/4"-18	10	<u>7.63</u>
<u>RB0261007220</u>	3/4"-22	10	<u>7.73</u>
<u>RB0261010220</u>	1"-22	10	<u>13.20</u>
<u>RB0261010280</u>	1"-28	10	<u>13.92</u>

RB 262



IT: Gomito a stringere femmina
FR: Coude à compression femelle

Codice	Misura	Box	€
<u>RB0262003120</u>	3/8"-12	10	<u>4.00</u>
<u>RB0262005120</u>	1/2"-12	10	<u>4.47</u>
<u>RB0262005140</u>	1/2"-14	10	<u>5.75</u>
<u>RB0262005150</u>	1/2"-15	10	<u>5.45</u>
<u>RB0262005160</u>	1/2"-16	10	<u>5.98</u>
<u>RB0262007180</u>	3/4"-18	10	<u>7.39</u>
<u>RB0262007220</u>	3/4"-22	10	<u>7.84</u>
<u>RB0262010220</u>	1"-22	10	<u>12.06</u>
<u>RB0262010280</u>	1"-28	10	<u>13.98</u>

IT: Raccordi a stringere per tubazioni rame (RB)

FR: Raccords laiton à compression pour tube cuivre (RB)

RB 250



IT: Tee a stringere
FR: Tee à compression

Codice	Misura	Box	€
RB0250000120	12	10	<u>5.22</u>
RB0250000140	14	10	<u>6.64</u>
RB0250000150	15	10	<u>7.28</u>
RB0250000160	16	10	<u>9.68</u>
RB0250000180	18	10	<u>9.84</u>
RB0250000220	22	10	<u>10.22</u>
RB0250000280	28	10	<u>16.86</u>
RB0250000350	35	5	<u>33.43</u>

RB 252

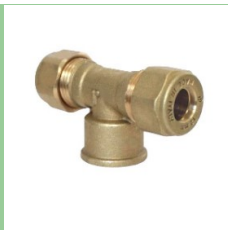

IT: Tee a stringere femmina
FR: Tee à compression femelle

Codice	Misura	Box	€
RB0252005120	1/2"-12	10	<u>5.98</u>
RB0252005140	1/2"-14	10	<u>8.00</u>
RB0252005150	1/2"-15	10	<u>7.26</u>
RB0252005160	1/2"-16	10	<u>7.45</u>
RB0252005180	1/2"-18	10	<u>7.80</u>
RB0252005220	1/2"-22	10	<u>8.57</u>

RB 253

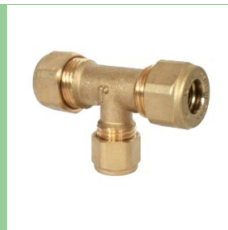

IT: Tee a stringere ridotto
FR: Tee réduit à compression

Codice	Misura	Box	€
RB025300BDB0	12-15-12	10	<u>6.39</u>
RB025300DBB0	15-12-12	10	<u>6.49</u>
RB025300DBD0	15-12-15	10	<u>7.12</u>
RB025300GDG0	22-15-22	10	<u>8.69</u>
RB025300GGD0	22-22-15	10	<u>9.88</u>
RB025300HDD0	28-15-28	10	<u>12.98</u>
RB025300HGH0	28-22-28	10	<u>15.45</u>
RB025300IGH0	35-22-35	5	<u>24.65</u>
RB025300IHH0	35-28-35	5	<u>26.94</u>

RB 270R



IT: Manicotto a stringere ridotto
FR: Manchon réduit à compression

Codice	Misura	Box	€
RB0270R01512	15-12	10	<u>3.57</u>
RB0270R02215	22-15	10	<u>6.47</u>
RB0270R02822	28-22	10	<u>9.65</u>
RB0270R03515	35-15	10	<u>19.41</u>

RB 263



IT: Gomito a stringere con base
FR: Coude applique à compression

Codice	Misura	Box	€
RB0263005120	1/2"-12	10	<u>7.51</u>
RB0263005140	1/2"-14	10	<u>8.16</u>
RB0263005150	1/2"-15	10	<u>9.06</u>
RB0263005160	1/2"-16	10	<u>9.63</u>

IT: Raccordi a stringere per tubazioni polietilene HD (RP)

FR: Raccords laiton à compression pour tube polyéthylène HD (RP)

RP 370



IT: Manicotto a stringere
FR: Manchon à compression

Codice	Misura	Box	€
RP0370000200	20	10	<u>7.36</u>
RP0370000250	25	10	<u>9.47</u>
RP0370000320	32	5	<u>14.01</u>
RP0370000400	40	3	<u>20.75</u>
RP0370000500	50	2	<u>32.39</u>
RP0370000630	63	1	<u>58.72</u>

RP 371



IT: Raccordo diritto maschio
FR: Manchon à compression male

Codice	Misura	Box	€
RP0371005200	1/2"-20	10	<u>4.47</u>
RP0371007250	3/4"-25	10	<u>5.35</u>
RP0371010320	1"-32	5	<u>8.56</u>
RP0371012400	1"1/4-40	3	<u>14.10</u>
RP0371015500	1"1/2-50	2	<u>19.85</u>
RP0371020630	2"-63	1	<u>33.30</u>

RP 380

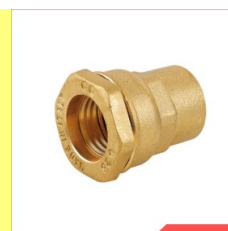

IT: Raccordo diritto femmina
FR: Manchon à compression femelle

Codice	Misura	Box	€
RP0380005200	1/2"-20	10	<u>4.33</u>
RP0380007250	3/4"-25	10	<u>5.77</u>
RP0380010320	1"-32	5	<u>8.64</u>
RP0380012400	1"1/4-40	3	<u>15.00</u>
RP0380015500	1"1/2-50	2	<u>20.84</u>
RP0380020630	2"-63	1	<u>35.01</u>

RP 360



IT: Curva a stringere femmina
FR: Coude à compression

Codice	Misura	Box	€
RP0360000200	20	10	<u>8.78</u>
RP0360000250	25	10	<u>11.21</u>
RP0360000320	32	5	<u>16.66</u>
RP0360000400	40	3	<u>26.64</u>
RP0360000500	50	2	<u>41.62</u>
RP0360000630	63	1	<u>67.27</u>

RP 361



IT: Gomito a stringere maschio
FR: Coude à compression male

Codice	Misura	Box	€
RP0361005200	1/2"-20	10	<u>5.35</u>
RP0361007250	3/4"-25	10	<u>7.20</u>
RP0361010320	1"-32	5	<u>10.60</u>
RP0361012400	1"1/4-40	3	<u>19.32</u>
RP0361015500	1"1/2-50	2	<u>31.81</u>
RP0361020630	2"-63	1	<u>53.79</u>

RP 362

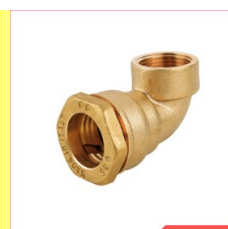

IT: Gomito a stringere femmina
FR: Coude à compression femelle

Codice	Misura	Box	€
RP0362005200	1/2"-20	10	<u>5.85</u>
RP0362007250	3/4"-25	10	<u>7.73</u>
RP0362010320	1"-32	5	<u>12.23</u>
RP0362012400	1"1/4-40	3	<u>19.55</u>
RP0362015500	1"1/2-50	2	<u>32.77</u>
RP0362020630	2"-63	1	<u>45.07</u>

IT: Raccordi a stringere per tubazioni polietilene HD (RP)

FR: Raccords laiton à compression pour tube polyéthylène HD (RP)

RP 363



IT: Gomito con base a stringere
FR: Applique à compression

Codice	Misura	Box	€
RP0363005200	1/2"-20	10	<u>7.43</u>
RP0363007250	3/4"-25	10	<u>10.46</u>
RP0363010320	1"-32	5	<u>15.08</u>

RP 350



IT: Tee a stringere
FR: Tee à compression

Codice	Misura	Box	€
RP0350002000	20	10	<u>11.90</u>
RP0350002500	25	10	<u>15.75</u>
RP0350003200	32	5	<u>24.00</u>
RP0350004000	40	3	<u>37.24</u>
RP0350005000	50	2	<u>65.67</u>
RP0350006300	63	1	<u>96.19</u>

RP 352

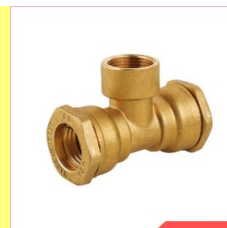

IT: Tee a stringere femmina
FR: Tee à compression femelle

Codice	Misura	Box	€
RP0352005200	1/2"-20	10	<u>10.32</u>
RP0352007250	3/4"-25	10	<u>12.65</u>
RP0352010320	1"-32	5	<u>20.41</u>
RP0352012400	1 1/4"-40	3	<u>30.10</u>
RP0352015500	1 1/2"-50	2	<u>53.26</u>
RP0352020630	2"-63	1	<u>86.08</u>

RP 370L



IT: Manicotto di riparazione
FR: Manchon réparation

Codice	Misura	Box	€
RP0370L02000	20	10	<u>7.46</u>
RP0370L02500	25	10	<u>10.67</u>
RP0370L03200	32	5	<u>16.50</u>
RP0370L04000	40	3	<u>25.79</u>
RP0370L05000	50	2	<u>37.00</u>
RP0370L06300	63	1	<u>58.91</u>

RP 390



IT: Raccordo diritto femmina con flangia
FR: Raccord droit femelle avec bride

Codice	Misura	Box	€
RP0390025750	2 1/2"-75	1	<u>104.01</u>
RP0390030900	3"-90	1	<u>176.58</u>
RP0390040110	4"-110	1	<u>287.56</u>

RP 391



IT: Raccordo diritto maschio con flangia
FR: Raccord droit male avec bride

Codice	Misura	Box	€
RP0391025750	2 1/2"-75	1	<u>104.31</u>
RP0391030900	3"-90	1	<u>169.94</u>
RP0391040110	4"-110	1	<u>281.05</u>

Sistemi filettati



IT: Raccordi filettati in ottone (RF)

FR: Raccords laiton à visser (RF)

RF 250F



IT: Tee femmina
FR: Tee femelle

Codice	Misura	Box	€
<u>RF0250F03000</u>	<u>3/8"</u>	<u>10</u>	<u>2.17</u>
<u>RF0250F05000</u>	<u>1/2"</u>	<u>10</u>	<u>2.34</u>
<u>RF0250F07000</u>	<u>3/4"</u>	<u>10</u>	<u>3.99</u>
<u>RF0250F10000</u>	<u>1"</u>	<u>10</u>	<u>7.03</u>
<u>RF0250F12000</u>	<u>1"1/4</u>	<u>5</u>	<u>15.76</u>
<u>RF0250F15000</u>	<u>1"1/2</u>	<u>5</u>	<u>22.84</u>
<u>RF0250F20000</u>	<u>2"</u>	<u>5</u>	<u>29.87</u>

RF 250A



IT: Tee maschio
FR: Tee male

Codice	Misura	Box	€
<u>RF0250A03000</u>	<u>3/8"</u>	<u>10</u>	<u>1.87</u>
<u>RF0250A05000</u>	<u>1/2"</u>	<u>10</u>	<u>3.08</u>
<u>RF0250A07000</u>	<u>3/4"</u>	<u>10</u>	<u>5.04</u>
<u>RF0250A10000</u>	<u>1"</u>	<u>10</u>	<u>8.60</u>

RF 260F



IT: Curva femmina
FR: Coude femelle

Codice	Misura	Box	€
<u>RF0260F03000</u>	<u>3/8"</u>	<u>10</u>	<u>1.87</u>
<u>RF0260F05000</u>	<u>1/2"</u>	<u>10</u>	<u>1.95</u>
<u>RF0260F07000</u>	<u>3/4"</u>	<u>10</u>	<u>3.13</u>
<u>RF0260F10000</u>	<u>1"</u>	<u>10</u>	<u>5.69</u>
<u>RF0260F12000</u>	<u>1"1/4</u>	<u>5</u>	<u>13.24</u>
<u>RF0260F15000</u>	<u>1"1/2</u>	<u>5</u>	<u>19.62</u>
<u>RF0260F20000</u>	<u>2"</u>	<u>5</u>	<u>28.48</u>

RF 260A



IT: Curva maschio
FR: Coude male

Codice	Misura	Box	€
<u>RF0260A03000</u>	<u>3/8"</u>	<u>10</u>	<u>1.69</u>
<u>RF0260A05000</u>	<u>1/2"</u>	<u>10</u>	<u>2.87</u>
<u>RF0260A07000</u>	<u>3/4"</u>	<u>10</u>	<u>3.47</u>
<u>RF0260A10000</u>	<u>1"</u>	<u>10</u>	<u>8.03</u>

RF 262A



IT: Curva maschio femmina
FR: Coude male femelle

Codice	Misura	Box	€
<u>RF0262A03000</u>	<u>3/8"</u>	<u>10</u>	<u>1.61</u>
<u>RF0262A05000</u>	<u>1/2"</u>	<u>10</u>	<u>1.91</u>
<u>RF0262A07000</u>	<u>3/4"</u>	<u>10</u>	<u>3.17</u>
<u>RF0262A10000</u>	<u>1"</u>	<u>10</u>	<u>5.38</u>
<u>RF0262A12000</u>	<u>1"1/4</u>	<u>5</u>	<u>12.81</u>
<u>RF0262A15000</u>	<u>1"1/2</u>	<u>5</u>	<u>19.97</u>
<u>RF0262A20000</u>	<u>2"</u>	<u>5</u>	<u>29.78</u>

RF 263



IT: Curva femmina con base
FR: Coude applique femelle

Codice	Misura	Box	€
<u>RF0263005000</u>	<u>1/2"</u>	<u>10</u>	<u>3.95</u>

IT: Raccordi filettati in ottone (RF)

FR: Raccords laiton à visser (RF)

RF 270F



IT: Manicotto
FR: Manchon femelle

Codice	Misura	Box	€
RF0270F05000	1/2"	10	1.82
RF0270F07000	3/4"	10	2.52
RF0270F10000	1"	10	3.86
RF0270F12000	1" 1/4	5	7.29
RF0270F15000	1" 1/2	5	10.81
RF0270F20000	2"	1	16.93

RF 270A



IT: Nipplo
FR: Mamelon male

Codice	Misura	Box	€
RF0270A03000	3/8"	10	0.91
RF0270A05000	1/2"	10	1.00
RF0270A07000	3/4"	10	1.74
RF0270A10000	1"	10	2.60
RF0270A12000	1" 1/4	5	5.08
RF0270A15000	1" 1/2	5	7.03
RF0270A20000	2"	1	11.03

RF 287



IT: Riduzione maschio femmina
FR: Réduction male femelle

Codice	Misura	Box	€
RF0287003020	3/8"-1/4"	10	0.69
RF0287005020	1/2"-1/4"	10	1.22
RF0287005030	1/2"-3/8"	10	0.82
RF0287007050	3/4"-1/2"	10	1.09
RF0287010030	1"-3/8"	10	3.39
RF0287010050	1"-1/2"	10	2.34
RF0287010070	1"-3/4"	10	1.69
RF0287012050	1"1/4-1/2"	5	5.90
RF0287012070	1"1/4-3/4"	5	5.47
RF0287012100	1"1/4-1"	5	3.95
RF0287015050	1"1/2-1/2"	5	8.51
RF0287015070	1"1/2-3/4"	5	7.86
RF0287015100	1"1/2-1"	5	6.60
RF0287015120	1"1/2-1"1/4	5	4.38
RF0287020100	2"-1"	5	15.80
RF0287020120	2"-1"1/4	5	14.98
RF0287020150	2"-1"1/2	5	12.07

RF 291



IT: Nipplo ridotto
FR: Mamelon réduit

Codice	Misura	Box	€
RF0291003020	3/8"-1/4"	10	1.00
RF0291005020	1/2"-1/4"	10	1.30
RF0291005030	1/2"-3/8"	10	1.17
RF0291007050	3/4"-1/2"	10	1.69
RF0291010050	1"-1/2"	10	2.78
RF0291010070	1"-3/4"	10	2.87
RF0291012050	1"1/4-1/2"	5	5.25
RF0291012070	1"1/4-3/4"	5	4.95
RF0291012100	1"1/4-1"	5	4.95
RF0291015100	1"1/2-1"	5	7.55
RF0291015120	1"1/2-1"1/4	5	8.42
RF0291020120	2"-1"1/4	5	11.55
RF0291020150	2"-1"1/2	5	11.98

RF 294



IT: Manicotto ridotto
FR: Manchon réduit

Codice	Misura	Box	€
RF0294005030	1/2"-3/8"	10	1.56
RF0294007050	3/4"-1/2"	10	3.08
RF0294010070	1"-3/4"	10	3.69
RF0294012070	1"1/4-3/4"	5	8.34
RF0294012100	1"1/4-1"	5	7.29
RF0294015100	1"1/2-1"	5	9.94
RF0294015120	1"1/2-1"1/4	5	10.98
RF0294020150	2-1"1/2	5	15.76

RF 295



IT: Riduzione femmina maschio
FR: Réduction femelle male

Codice	Misura	Box	€
RF0295005020	1/2"-1/4"	10	1.69
RF0295005030	1/2"-3/8"	10	1.61
RF0295007050	3/4"-1/2"	10	1.69
RF0295010050	1"-1/2"	10	3.17
RF0295010070	1"-3/4"	10	3.04
RF0295012100	1"1/4-1"	5	4.47
RF0295015100	1"1/2-1"	5	9.20
RF0295015120	1"1/2-1"1/4	5	8.25

IT: Raccordi filettati in ottone (RF)

FR: Raccords laiton à visser (RF)

RT 124



IT: Raccordo diritto 3 pezzi F/F
FR: Union droit 3 pièces femelle femelle

Codice	Misura	Box	€
RT0124000005	1/2"	10	<u>6.99</u>
RT0124000007	3/4"	10	<u>9.94</u>
RT0124000010	1"	10	<u>14.46</u>

RT 125



IT: Raccordo curvo 3 pezzi M/F
FR: Coude union 3 pièces male femelle

Codice	Misura	Box	€
RT0125003000	3/8"	10	<u>4.73</u>
RT0125005000	1/2"	10	<u>5.64</u>
RT0125007000	3/4"	10	<u>8.47</u>
RT0125010000	1"	10	<u>13.76</u>
RT0125012000	1"1/4	5	<u>22.14</u>
RT0125015000	1"1/2	5	<u>38.38</u>

RT 126



IT: Raccordo diritto 3 pezzi M/F
FR: Union droit 3 pièces male femelle

Codice	Misura	Box	€
RT0126003000	3/8"	10	<u>4.08</u>
RT0126005000	1/2"	10	<u>4.34</u>
RT0126007000	3/4"	10	<u>6.21</u>
RT0126010000	1"	10	<u>9.94</u>
RT0126012000	1"1/4	5	<u>15.80</u>
RT0126015000	1"1/2	5	<u>24.83</u>
RT0126020000	2"	5	<u>45.15</u>

RT 127

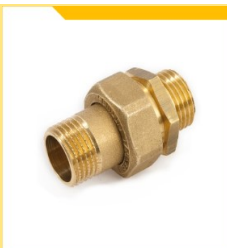

IT: Raccordo diritto 3 pezzi M/M
FR: Union droit 3 pièces male male

Codice	Misura	Box	€
RT0127003000	3/8"	10	<u>3.73</u>
RT0127005000	1/2"	10	<u>5.08</u>
RT0127007000	3/4"	10	<u>8.73</u>
RT0127010000	1"	10	<u>13.76</u>

RF 275L



IT: Prolunga ottone giallo
FR: Extension laiton

Codice	Misura	Box	€
RF0275L00510	1/2"-10	10	<u>1.52</u>
RF0275L00515	1/2"-15	10	<u>1.91</u>
RF0275L00520	1/2"-20	10	<u>2.30</u>
RF0275L00525	1/2"-25	10	<u>2.69</u>
RF0275L00530	1/2"-30	10	<u>2.91</u>
RF0275L00540	1/2"-40	10	<u>3.65</u>
RF0275L00550	1/2"-50	10	<u>4.25</u>
RF0275L00710	3/4"-10	10	<u>2.26</u>
RF0275L00715	3/4"-15	10	<u>2.78</u>
RF0275L00720	3/4"-20	10	<u>3.26</u>
RF0275L00725	3/4"-25	10	<u>3.60</u>
RF0275L00730	3/4"-30	10	<u>3.99</u>
RF0250L00740	3/4"-40	10	<u>4.95</u>
RF0275L00750	3/4"-50	10	<u>5.56</u>
RF0275L01010	1"-10	10	<u>3.78</u>
RF0275L01015	1"-15	10	<u>4.43</u>
RF0275L01020	1"-20	10	<u>5.17</u>
RF0275L01025	1"-25	10	<u>5.86</u>
RF0275L01030	1"-30	10	<u>6.38</u>
RF0275L01040	1"-40	10	<u>7.81</u>
RF0275L01050	1"-50	10	<u>8.86</u>

RF 275LC



IT: Prolunga ottone cromato
FR: Extension laiton chromé

Codice	Misura	Box	€
RF0275L00510C	1/2"-10	10	<u>1.90</u>
RF0275L00515C	1/2"-15	10	<u>2.69</u>
RF0275L00520C	1/2"-20	10	<u>2.87</u>
RF0275L00525C	1/2"-25	10	<u>3.36</u>
RF0275L00530C	1/2"-30	10	<u>3.64</u>
RF0275L00540C	1/2"-40	10	<u>4.56</u>
RF0275L00550C	1/2"-50	10	<u>5.31</u>
RF0275L00710C	3/4"-10	10	<u>2.82</u>
RF0275L00715C	3/4"-15	10	<u>3.47</u>
RF0275L00720C	3/4"-20	10	<u>4.07</u>
RF0275L00725C	3/4"-25	10	<u>4.98</u>
RF0275L00730C	3/4"-30	10	<u>4.98</u>
RF0250L00740C	3/4"-40	10	<u>6.18</u>
RF0275L00750C	3/4"-50	10	<u>6.95</u>
RF0275L01010C	1"-10	10	<u>4.72</u>
RF0275L01015C	1"-15	10	<u>5.54</u>
RF0275L01020C	1"-20	10	<u>6.46</u>
RF0275L01025C	1"-25	10	<u>7.32</u>
RF0275L01030C	1"-30	10	<u>7.97</u>
RF0275L01040C	1"-40	10	<u>9.76</u>
RF0275L01050C	1"-50	10	<u>11.10</u>

IT: Raccordi filettati in ottone (RF)

FR: Raccords laiton à visser (RF)

RF 286



IT: Tappo maschio
FR: Bouchon male

Codice	Misura	Box	€
RF0286003000	3/8"	10	0.78
RF0286005000	1/2"	10	0.91
RF0286007000	3/4"	10	1.43
RF0286010000	1"	10	2.08
RF0286012000	1" 1/4	5	4.30
RF0286015000	1" 1/2	5	6.16
RF0286020000	2"	1	8.73

RF 288



IT: Tappo femmina
FR: Bouchon femelle

Codice	Misura	Box	€
RF0288005000	1/2"	10	0.74
RF0288007000	3/4"	10	1.30
RF0288010000	1"	10	1.95
RF0288012000	1" 1/4	5	3.82
RF0288015000	1" 1/2	5	5.86
RF0288020000	2"	1	7.68

RF 180



IT: Raccordo a croce
FR: Croix égal laiton

Codice	Misura	Box	€
RF0180000005	1/2"	10	5.80
RF0180000007	3/4"	10	9.02
RF0180000010	1"	10	15.27

IT: Raccordi filettati in acciaio inox AISI 316L (RFX)

FR: Raccords acier inoxydable AISI 316L (RFX)

RFX 130



IT: Tee femmina
FR: Tee femelle

Codice	Misura	Box	€
<u>RFX130000003</u>	<u>3/8"</u>	<u>10</u>	<u>5.17</u>
<u>RFX130000005</u>	<u>1/2"</u>	<u>10</u>	<u>5.23</u>
<u>RFX130000007</u>	<u>3/4"</u>	<u>10</u>	<u>7.72</u>
<u>RFX130000010</u>	<u>1"</u>	<u>10</u>	<u>11.15</u>
<u>RFX130000012</u>	<u>1" 1/4</u>	<u>5</u>	<u>17.16</u>
<u>RFX130000015</u>	<u>1" 1/2</u>	<u>5</u>	<u>22.48</u>
<u>RFX130000020</u>	<u>2"</u>	<u>1</u>	<u>34.83</u>

RFX 90



IT: Curva femmina
FR: Coude femelle

Codice	Misura	Box	€
<u>RFX090000003</u>	<u>3/8"</u>	<u>10</u>	<u>3.16</u>
<u>RFX090000005</u>	<u>1/2"</u>	<u>10</u>	<u>3.60</u>
<u>RFX090000007</u>	<u>3/4"</u>	<u>10</u>	<u>5.73</u>
<u>RFX090000010</u>	<u>1"</u>	<u>10</u>	<u>8.58</u>
<u>RFX090000012</u>	<u>1" 1/4</u>	<u>5</u>	<u>12.40</u>
<u>RFX090000015</u>	<u>1" 1/2</u>	<u>5</u>	<u>16.99</u>
<u>RFX090000020</u>	<u>2"</u>	<u>1</u>	<u>26.73</u>

RFX 92



IT: Curva maschio femmina
FR: Coude male femelle

Codice	Misura	Box	€
<u>RFX092000003</u>	<u>3/8"</u>	<u>10</u>	<u>4.08</u>
<u>RFX092000005</u>	<u>1/2"</u>	<u>10</u>	<u>4.12</u>
<u>RFX092000007</u>	<u>3/4"</u>	<u>10</u>	<u>6.35</u>
<u>RFX092000010</u>	<u>1"</u>	<u>10</u>	<u>10.29</u>
<u>RFX092000012</u>	<u>1" 1/4</u>	<u>5</u>	<u>14.79</u>
<u>RFX092000015</u>	<u>1" 1/2</u>	<u>5</u>	<u>19.56</u>
<u>RFX092000020</u>	<u>2"</u>	<u>1</u>	<u>27.19</u>

RFX 270



IT: Manicotto
FR: Manchon femelle

Codice	Misura	Box	€
<u>RFX270000003</u>	<u>3/8"</u>	<u>10</u>	<u>3.12</u>
<u>RFX270000005</u>	<u>1/2"</u>	<u>10</u>	<u>3.60</u>
<u>RFX270000007</u>	<u>3/4"</u>	<u>10</u>	<u>4.80</u>
<u>RFX270000010</u>	<u>1"</u>	<u>10</u>	<u>6.43</u>
<u>RFX270000012</u>	<u>1" 1/4</u>	<u>5</u>	<u>9.54</u>
<u>RFX270000015</u>	<u>1" 1/2</u>	<u>5</u>	<u>10.50</u>
<u>RFX270000020</u>	<u>2"</u>	<u>1</u>	<u>20.07</u>

RFX 240



IT: Manicotto ridotto
FR: Manchon femelle réduit

Codice	Misura	Box	€
<u>RFX240005030</u>	<u>1/2"-3/8"</u>	<u>10</u>	<u>4.29</u>
<u>RFX240007050</u>	<u>3/4"-1/2"</u>	<u>10</u>	<u>5.66</u>
<u>RFX240010070</u>	<u>1"-3/4"</u>	<u>10</u>	<u>8.58</u>
<u>RFX240012100</u>	<u>1"1/4-1"</u>	<u>10</u>	<u>12.42</u>
<u>RFX240015120</u>	<u>1"1/2-1"1/4</u>	<u>5</u>	<u>15.27</u>
<u>RFX240020150</u>	<u>2"-1"1/2</u>	<u>5</u>	<u>21.45</u>

RFX 280



IT: Nipplo
FR: Mamelon male

Codice	Misura	Box	€
<u>RFX280000003</u>	<u>3/8"</u>	<u>10</u>	<u>2.49</u>
<u>RFX280000005</u>	<u>1/2"</u>	<u>10</u>	<u>3.05</u>
<u>RFX280000007</u>	<u>3/4"</u>	<u>10</u>	<u>4.20</u>
<u>RFX280000010</u>	<u>1"</u>	<u>10</u>	<u>7.64</u>
<u>RFX280000012</u>	<u>1" 1/4</u>	<u>5</u>	<u>9.57</u>
<u>RFX280000015</u>	<u>1" 1/2</u>	<u>5</u>	<u>12.87</u>
<u>RFX280000020</u>	<u>2"</u>	<u>1</u>	<u>18.62</u>

IT: Raccordi filettati in acciaio inox AISI 316L (RFX)

FR: Raccords acier inoxydable AISI 316L (RFX)

RFX 245



IT: Niplo ridotto
FR: mamelon male réduit

Codice	Misura	Box	€
RFX245005030	1/2"-3/8"	10	<u>3.35</u>
RFX245007050	3/4"-1/2"	10	<u>4.80</u>
RFX245010070	1"-3/4"	10	<u>6.69</u>
RFX245012100	1"1/4-1"	10	<u>10.50</u>
RFX245015120	1"1/2-1"1/4	5	<u>13.90</u>
RFX245020120	2"-1"1/4	5	<u>18.19</u>
RFX245020150	2"-1"1/2	5	<u>18.19</u>

RFX 241



IT: Riduzione maschio femmina
FR: Réduction male femelle

Codice	Misura	Box	€
RFX241003020	3/8"-1/4"	10	<u>2.40</u>
RFX241005030	1/2"-3/8"	10	<u>2.57</u>
RFX241007050	3/4"-1/2"	10	<u>4.29</u>
RFX241010050	1"-1/2"	10	<u>6.01</u>
RFX241010070	1"-3/4"	10	<u>6.01</u>
RFX241012070	1"1/4-3/4"	5	<u>9.44</u>
RFX241012100	1"1/4-1"	5	<u>9.44</u>
RFX241015100	1"1/2-1"	5	<u>11.67</u>
RFX241015120	1"1/2-1"1/4	5	<u>11.67</u>

RFX 341



IT: Raccordo diretto 3 pezzi M/F
FR: Union droit male femelle

Codice	Misura	Box	€
RFX341000003	3/8"	10	<u>10.55</u>
RFX341000005	1/2"	10	<u>11.50</u>
RFX341000007	3/4"	10	<u>16.73</u>
RFX341000010	1"	10	<u>24.71</u>
RFX341000012	1"1/4	5	<u>33.37</u>
RFX341000015	1"1/2	5	<u>39.12</u>
RFX341000020	2"	5	<u>59.62</u>

RFX 290



IT: Tappo Maschio
FR: Bouchon male

Codice	Misura	Box	€
RFX290000003	3/8"	10	<u>2.49</u>
RFX290000005	1/2"	10	<u>2.78</u>
RFX290000007	3/4"	10	<u>4.29</u>
RFX290000010	1"	5	<u>5.75</u>
RFX290000012	1" 1/4	5	<u>8.15</u>
RFX290000015	1"1/2	5	<u>10.98</u>
RFX290000020	2"	1	<u>17.16</u>

RFX 300



IT: Tappo femmina
FR: Bouchon femelle

Codice	Misura	Box	€
RFX300000003	3/8"	10	<u>2.44</u>
RFX300000005	1/2"	10	<u>3.43</u>
RFX300000007	3/4"	10	<u>4.33</u>
RFX300000010	1"	5	<u>6.21</u>
RFX300000012	1" 1/4	5	<u>9.57</u>
RFX300000015	1"1/2	5	<u>11.70</u>
RFX300000020	2"	1	<u>19.08</u>

IT: Raccordi in ghisa malleabile (RA)

FR: Raccords fonte (RA)

RA 90



IT: Curva femmina
FR: Coude femelle

Codice	Misura	Box	€
RA0090000003	3/8"	10	<u>1.62</u>
RA0090000005	1/2"	10	<u>1.09</u>
RA0090000007	3/4"	10	<u>1.55</u>
RA0090000010	1"	10	<u>2.38</u>
RA0090000012	1" 1/4	5	<u>4.61</u>
RA0090000015	1" 1/2	5	<u>6.26</u>
RA0090000020	2"	1	<u>9.25</u>
RA0090000025	2" 1/2	1	<u>19.44</u>
RA0090000030	3"	1	<u>30.24</u>
RA0090000040	4"	1	<u>53.57</u>

RA 91



IT: Curva femmina ridotta
FR: Coude femelle réduit

Codice	Misura	Box	€
RA0091000705	3/4" - 1/2"	10	<u>2.33</u>
RA0091001005	1" - 1/2"	10	<u>3.42</u>
RA0091001007	1" - 3/4"	10	<u>3.58</u>
RA0091001210	1" 1/4 - 1"	5	<u>5.82</u>
RA0091001510	1" 1/2 - 1"	5	<u>8.52</u>
RA0091001512	1" 1/2 - 1" 1/4	5	<u>9.26</u>
RA0091002015	2" - 1" 1/2	5	<u>14.92</u>
RA0091002520	2" 1/2 - 2"	5	<u>36.10</u>
RA0091003020	3" - 2"	5	<u>68.77</u>

RA 92



IT: Curva maschio femmina
FR: Coude male femelle

Codice	Misura	Box	€
RA0092000003	3/8"	10	<u>1.81</u>
RA0092000005	1/2"	10	<u>1.26</u>
RA0092000007	3/4"	10	<u>1.98</u>
RA0092000010	1"	10	<u>3.31</u>
RA0092000012	1" 1/4	5	<u>5.69</u>
RA0092000015	1" 1/2	5	<u>8.54</u>
RA0092000020	2"	1	<u>11.22</u>
RA0092000025	2" 1/2	1	<u>27.93</u>
RA0092000030	3"	1	<u>36.77</u>
RA0092000040	4"	1	<u>62.80</u>

RA 130



IT: Tee femmina
FR: Tee femelle

Codice	Misura	Box	€
RA0130000003	3/8"	10	<u>2.26</u>
RA0130000005	1/2"	10	<u>1.46</u>
RA0130000007	3/4"	10	<u>2.54</u>
RA0130000010	1"	10	<u>3.73</u>
RA0130000012	1" 1/4	5	<u>6.59</u>
RA0130000015	1" 1/2	5	<u>10.25</u>
RA0130000020	2"	1	<u>14.41</u>
RA0130000025	2" 1/2	1	<u>33.03</u>
RA0130000030	3"	1	<u>44.12</u>
RA0130000040	4"	1	<u>86.41</u>

RA 131



IT: Tee femmina ridotto
FR: Tee femelle réduit

Codice	Misura	Box	€
RA0131050305	1/2" - 3/8" - 1/2"	10	<u>2.92</u>
RA0131070505	3/4" - 1/2" - 1/2"	10	<u>2.92</u>
RA0131070507	3/4" - 1/2" - 3/4"	10	<u>2.73</u>
RA0131100505	1" - 1/2" - 1/2"	10	<u>6.15</u>
RA0131100510	1" - 1/2" - 1"	10	<u>3.54</u>
RA0131100710	1" - 3/4" - 1"	10	<u>3.82</u>
RA0131101210	1" - 1" 1/4 - 1"	10	<u>8.88</u>
RA0131120512	1 1/4 - 1/2" - 1 1/4	5	<u>5.92</u>
RA0131120712	1 1/4 - 3/4" - 1 1/4	5	<u>6.27</u>
RA0131121012	1 1/4 - 1" - 1 1/4	5	<u>7.01</u>
RA0131150515	1 1/2 - 1/2" - 1 1/2	5	<u>7.99</u>
RA0131150715	1 1/2 - 3/4" - 1 1/2	5	<u>8.64</u>
RA0131151015	1 1/2 - 1" - 1 1/2	5	<u>9.34</u>
RA0131151215	1 1/2 - 1 1/4 - 1 1/2	5	<u>12.67</u>
RA0131200520	2" - 1/2" - 2"	1	<u>11.78</u>
RA0131200720	2" - 3/4" - 2"	1	<u>15.29</u>
RA0131201020	2" - 1" - 2"	1	<u>11.87</u>
RA0131201220	2" - 1" 1/4 - 2"	1	<u>15.29</u>
RA0131201520	2" - 1" 1/2 - 2"	1	<u>17.62</u>
RA0131250525	2 1/2 - 1/2" - 2 1/2	1	<u>43.78</u>
RA0131250725	2 1/2 - 3/4" - 2 1/2	1	<u>25.30</u>
RA0131251025	2 1/2 - 1" - 2 1/2	1	<u>24.25</u>
RA0131251225	2 1/2 - 1 1/4 - 2 1/2	1	<u>33.28</u>
RA0131251525	2 1/2 - 1 1/2 - 2 1/2	1	<u>28.97</u>
RA0131252025	2" 1/2 - 2" - 2" 1/2	1	<u>32.58</u>
RA0131301030	3" - 1" - 3"	1	<u>39.73</u>
RA0131301230	3" - 1" 1/4 - 3"	1	<u>45.69</u>
RA0131301530	3" - 1" 1/2 - 3"	1	<u>45.78</u>
RA0131302030	3" - 2" - 3"	1	<u>42.54</u>
RA0131402040	4" - 2" - 4"	1	<u>74.94</u>
RA0131403040	4" - 3" - 4"	1	<u>79.66</u>

RA 241



IT: Riduzione maschio femmina
FR: Réduction male femelle

Codice	Misura	Box	€
RA0241000503	1/2" - 3/8"	10	<u>1.12</u>
RA0241000703	3/4" - 3/8"	10	<u>1.56</u>
RA0241000705	3/4" - 1/2"	10	<u>1.18</u>
RA0241001005	1" - 1/2"	10	<u>1.66</u>
RA0241001007	1" - 3/4"	10	<u>1.56</u>
RA0241001205	1" 1/4 - 1/2"	5	<u>2.86</u>
RA0241001207	1" 1/4 - 3/4"	5	<u>2.56</u>
RA0241001210	1" 1/4 - 1"	5	<u>1.91</u>
RA0241001505	1" 1/2 - 1/2"	5	<u>3.80</u>
RA0241001507	1" 1/2 - 3/4"	5	<u>4.19</u>
RA0241001510	1" 1/2 - 1"	5	<u>2.82</u>
RA0241001512	1" 1/2 - 1" 1/4	5	<u>2.86</u>
RA0241002005	2" - 1/2"	1	<u>7.61</u>
RA0241002007	2" - 3/4"	1	<u>7.52</u>
RA0241002010	2" - 1"	1	<u>6.15</u>
RA0241002012	2" - 1" 1/4	1	<u>5.87</u>
RA0241002015	2" - 1" 1/2	1	<u>5.27</u>
RA0241002510	2" 1/2 - 1"	1	<u>12.11</u>
RA0241002512	2" 1/2 - 1" 1/4	1	<u>14.01</u>
RA0241002515	2" 1/2 - 1" 1/2	1	<u>13.23</u>
RA0241002520	2" 1/2 - 2"	1	<u>10.13</u>
RA0241003020	3" - 2"	1	<u>13.06</u>
RA0241003025	3" - 2" 1/2	1	<u>14.78</u>
RA0241004025	4" - 2" 1/2	1	<u>28.26</u>
RA0241004030	4" - 3"	1	<u>27.11</u>

IT: Raccordi in ghisa malleabile (RA)

FR: Raccords fonte (RA)

RA 270



IT: Manicotto
FR: Manchon femelle

Codice	Misura	Box	€
RA0270000003	3/8"	10	<u>1.48</u>
RA0270000005	1/2"	10	<u>1.26</u>
RA0270000007	3/4"	10	<u>1.58</u>
RA0270000010	1"	10	<u>2.34</u>
RA0270000012	1" 1/4	5	<u>3.67</u>
RA0270000015	1" 1/2	5	<u>4.79</u>
RA0270000020	2"	1	<u>6.95</u>
RA0270000025	2" 1/2	1	<u>20.93</u>
RA0270000030	3"	1	<u>25.14</u>
RA0270000040	4"	1	<u>58.61</u>

RA 240



IT: Manicotto ridotto
FR: Manchon femelle réduit

Codice	Misura	Box	€
RA0240000503	1/2"-3/8"	10	<u>1.91</u>
RA0240000705	3/4"-1/2"	10	<u>2.24</u>
RA0240001005	1" -1/2	10	<u>2.82</u>
RA0240001007	1"-3/4"	5	<u>2.56</u>
RA0240001205	1"1/4-1/2	5	<u>5.35</u>
RA0240001210	1"1/4-1"	1	<u>4.59</u>
RA0240001512	1"1/2-1"1/4	1	<u>6.15</u>
RA0240002015	2"-1"1/2	1	<u>9.17</u>
RA0240002515	2"1/2-1"1/2	1	<u>29.12</u>
RA0240003020	3" - 2"	1	<u>38.94</u>
RA0240003025	3" -2"1/2	1	<u>44.31</u>

RA 246



IT: Riduzione femmina maschio
FR: Réduction femelle male

Codice	Misura	Box	€
RA0246000503	1/2"-3/8"	10	<u>2.12</u>
RA0246000705	3/4"-1/2"	10	<u>2.28</u>
RA0246001005	1" -1/2	10	<u>3.49</u>
RA0246001007	1"-3/4"	5	<u>3.70</u>
RA0246001205	1"1/4-1/2	5	<u>8.94</u>
RA0246001210	1"1/4-1"	1	<u>4.10</u>
RA0246001512	1"1/2-1"1/4	1	<u>6.89</u>
RA0246002015	2"-1"1/2	1	<u>11.78</u>
RA0246003020	3" - 2"	1	<u>27.93</u>
RA0246003025	3" -2"1/2	1	<u>34.19</u>

RA 280



IT: Nipplo
FR: Mamelon male

Codice	Misura	Box	€
RA0280000003	3/8"	10	<u>1.62</u>
RA0280000005	1/2"	10	<u>0.97</u>
RA0280000007	3/4"	10	<u>1.26</u>
RA0280000010	1"	10	<u>1.84</u>
RA0280000012	1" 1/4	5	<u>3.35</u>
RA0280000015	1" 1/2	5	<u>4.18</u>
RA0280000020	2"	1	<u>6.41</u>
RA0280000025	2" 1/2	1	<u>12.13</u>
RA0280000030	3"	1	<u>16.16</u>
RA0280000040	4"	1	<u>43.85</u>

RA 245



IT: Nipplo ridotto
FR: Mamelon male réduit

Codice	Misura	Box	€
RA0245000503	1/2"-3/8"	10	<u>2.65</u>
RA0245000705	3/4"-1/2"	10	<u>2.30</u>
RA0245001007	1"-3/4"	10	<u>2.65</u>
RA0245001210	1"1/4-1"	5	<u>4.19</u>
RA0245001512	1"1/2-1"1/4	5	<u>5.29</u>
RA0245002015	2"-1"1/2	1	<u>9.99</u>
RA0245002520	2"1/2-2"	1	<u>23.93</u>
RA0245003025	3"-2"1/2	1	<u>38.66</u>
RA0245004030	4"-3"	1	<u>72.56</u>

RA 85



IT: Scavalamento
FR: Manchon by-pass

Codice	Misura	Box	€
RA0085000005	1/2"	10	<u>4.47</u>
RA0085000007	3/4"	10	<u>6.75</u>
RA0085000010	1"	10	<u>14.01</u>
RA0085000012	1" 1/4	5	<u>26.30</u>

IT: Raccordi in ghisa malleabile (RA)

FR: Raccords fonte (RA)

RA 01



IT: Curva ampia femmina femmina
FR: Coude large femelle femelle

Codice	Misura	Box	€
RA0010000005	1/2"	10	<u>3.10</u>
RA0010000007	3/4"	10	<u>5.38</u>
RA0010000010	1"	10	<u>7.33</u>
RA0010000012	1" 1/4	5	<u>12.62</u>
RA0010000015	1" 1/2	5	<u>16.69</u>
RA0010000020	2"	1	<u>26.91</u>

RA 02



IT: Curva ampia maschio femmina
FR: Coude large male femelle

Codice	Misura	Box	€
RA0020000005	1/2"	10	<u>3.49</u>
RA0020000007	3/4"	10	<u>5.40</u>
RA0020000010	1"	10	<u>7.33</u>
RA0020000012	1" 1/4	5	<u>12.67</u>
RA0020000015	1" 1/2	5	<u>15.57</u>
RA0020000020	2"	1	<u>21.62</u>

RA 120



IT: Curva femmina 45°
FR: Coude femelle 45°

Codice	Misura	Box	€
RA0120000003	3/8"	10	<u>4.38</u>
RA0120000005	1/2"	10	<u>3.68</u>
RA0120000007	3/4"	10	<u>4.54</u>
RA0120000010	1"	10	<u>6.59</u>
RA0120000012	1" 1/4	5	<u>11.99</u>
RA0120000015	1" 1/2	5	<u>14.64</u>
RA0120000020	2"	1	<u>19.11</u>

RA 121



IT: Curva maschio femmina 45°
FR: Coude male femelle 45°

Codice	Misura	Box	€
RA0121000003	3/8"	10	<u>3.42</u>
RA0121000005	1/2"	10	<u>3.38</u>
RA0121000007	3/4"	10	<u>4.29</u>
RA0121000010	1"	10	<u>6.59</u>
RA0121000012	1" 1/4	5	<u>12.34</u>
RA0121000015	1" 1/2	5	<u>13.29</u>
RA0121000020	2"	1	<u>16.83</u>

RA 290



IT: Tappo maschio
FR: Bouchon male

Codice	Misura	Box	€
RA0290000003	3/8"	10	<u>0.87</u>
RA0290000005	1/2"	10	<u>0.87</u>
RA0290000007	3/4"	10	<u>1.18</u>
RA0290000010	1"	10	<u>1.30</u>
RA0290000012	1" 1/4	5	<u>2.47</u>
RA0290000015	1" 1/2	5	<u>3.01</u>
RA0290000020	2"	1	<u>5.36</u>
RA0290000025	2" 1/2	1	<u>11.74</u>
RA0290000030	3"	1	<u>15.11</u>
RA0290000040	4"	1	<u>26.67</u>

RA 300



IT: Tappo femmina
FR: Bouchon femelle

Codice	Misura	Box	€
RA0300000003	3/8"	10	<u>1.26</u>
RA0300000005	1/2"	10	<u>1.42</u>
RA0300000007	3/4"	10	<u>1.71</u>
RA0300000010	1"	10	<u>2.00</u>
RA0300000012	1" 1/4	5	<u>3.01</u>
RA0300000015	1" 1/2	5	<u>3.74</u>
RA0300000020	2"	1	<u>7.06</u>
RA0300000025	2" 1/2	1	<u>12.88</u>
RA0300000030	3"	1	<u>14.04</u>
RA0300000040	4"	1	<u>30.68</u>

IT: Raccordi in ghisa malleabile (RA)

FR: Raccords fonte (RA)

RA 340



IT: Raccordo diritto 3 pezzi F/F
FR: Union droit 3 pièces femelle femelle

Codice	Misura	Box	€
RA034000003	3/8"	10	<u>7.33</u>
RA034000005	1/2"	10	<u>7.08</u>
RA034000007	3/4"	10	<u>6.36</u>
RA034000010	1"	10	<u>7.34</u>
RA034000012	1" 1/4	5	<u>12.62</u>
RA034000015	1" 1/2	5	<u>14.78</u>
RA034000020	2"	1	<u>24.32</u>
RA034000025	2" 1/2	1	<u>53.46</u>
RA034000030	3"	1	<u>74.54</u>
RA034000040	4"	1	<u>150.50</u>

RA 341



IT: Raccordo diritto 3 pezzi M/F
FR: Union droit 3 pièces male femelle

Codice	Misura	Box	€
RA034100003	3/8"	10	<u>6.59</u>
RA034100005	1/2"	10	<u>5.48</u>
RA034100007	3/4"	10	<u>6.59</u>
RA034100010	1"	10	<u>8.19</u>
RA034100012	1" 1/4	5	<u>13.04</u>
RA034100015	1" 1/2	5	<u>16.69</u>
RA034100020	2"	1	<u>26.63</u>
RA034100025	2" 1/2	1	<u>58.33</u>
RA034100030	3"	1	<u>91.21</u>
RA034100040	4"	1	<u>167.21</u>

RA 96



IT: Raccordo curvo 3 pezzi F/F
FR: Coude union 3 pièces femelle femelle

Codice	Misura	Box	€
RA009600003	3/8"	10	<u>10.15</u>
RA009600005	1/2"	10	<u>7.52</u>
RA009600007	3/4"	10	<u>8.70</u>
RA009600010	1"	10	<u>12.48</u>
RA009600012	1" 1/4	5	<u>20.78</u>
RA009600015	1" 1/2	5	<u>24.77</u>
RA009600020	2"	1	<u>41.76</u>
RA009600025	2" 1/2	1	<u>89.51</u>
RA009600030	3"	1	<u>116.23</u>

RA 98



IT: Raccordo curvo 3 pezzi M/F
FR: Coude union 3 pièces male femelle

Codice	Misura	Box	€
RA009800003	3/8"	10	<u>9.01</u>
RA009800005	1/2"	10	<u>7.55</u>
RA009800007	3/4"	10	<u>9.57</u>
RA009800010	1"	5	<u>13.11</u>
RA009800012	1" 1/4	5	<u>21.98</u>
RA009800015	1" 1/2	1	<u>26.91</u>
RA009800020	2"	1	<u>44.48</u>
RA009800025	2" 1/2	1	<u>98.79</u>
RA009800030	3"	1	<u>132.42</u>

RA 180



IT: Raccordo a croce
FR: Croix égal fonte

Codice	Misura	Box	€
RA018000003	3/8"	10	<u>5.38</u>
RA018000005	1/2"	10	<u>5.29</u>
RA018000007	3/4"	10	<u>7.87</u>
RA018000010	1"	10	<u>9.75</u>
RA018000012	1" 1/4	5	<u>13.08</u>
RA018000015	1" 1/2	5	<u>17.43</u>
RA018000020	2"	1	<u>26.02</u>

RA 471



IT: Curva femmina con base
FR: Coude applique femelle

Codice	Misura	Box	€
RA047100005	1/2"	10	<u>7.01</u>
RA047100007	3/4"	10	<u>13.48</u>

IT: Raccordi in ghisa malleabile (RA)

FR: Raccords fonte (RA)

RA 500

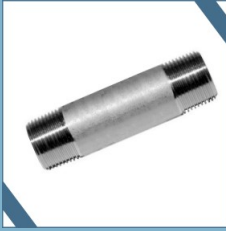

IT: Barilotto ghisa
FR: Bobine fonte

Codice	Misura	Box	€
RA0500030060	3/8"-60	1	1.19
RA0500030080	3/8"-80	1	1.66
RA0500030100	3/8"-100	1	1.43
RA0500030120	3/8"-120	1	1.70
RA0500030150	3/8"-150	1	1.99
RA0500030200	3/8"-200	1	2.50
RA0500050060	1/2"-60	1	1.19
RA0500050080	1/2"-80	1	1.66
RA0500050100	1/2"-100	1	1.43
RA0500050120	1/2"-120	1	1.70
RA0500050150	1/2"-150	1	1.99
RA0500050200	1/2"-200	1	2.50
RA0500050250	1/2"-250	1	2.97
RA0500050300	1/2"-300	1	3.54
RA0500070060	3/4"-60	1	1.43
RA0500070080	3/4"-80	1	1.66
RA0500070100	3/4"-100	1	1.76
RA0500070120	3/4"-120	1	1.95
RA0500070150	3/4"-150	1	2.40
RA0500070200	3/4"-200	1	2.97
RA0500100060	1"-60	1	1.76
RA0500100080	1"-80	1	1.99
RA0500100100	1"-100	1	2.40
RA0500100150	1"-150	1	3.13
RA0500100200	1"-200	1	3.93
RA0500120100	1"1/4-100	1	2.68
RA0500150100	1"1/2-100	1	3.36
RA0500200100	2"-100	1	4.57

RF 500

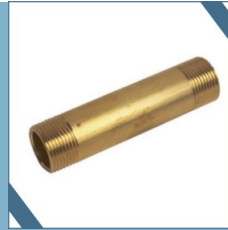

IT: Barilotto ottone
FR: Bobine laiton

Codice	Misura	Box	€
RF0500030050	3/8"-50	1	
RF0500030060	3/8"-60	1	
RF0500030070	3/8"-70	1	
RF0500030080	3/8"-80	1	
RF0500030090	3/8"-90	1	
RF0500030100	3/8"-100	1	
RF0500030120	3/8"-120	1	
RF0500030150	3/8"-150	1	
RF0500030200	3/8"-200	1	
RF0500030250	3/8"-250	1	
RF0500050050	1/2"-50	1	
RF0500050060	1/2"-60	1	
RF0500050070	1/2"-70	1	
RF0500050080	1/2"-80	1	
RF0500050090	1/2"-90	1	
RF0500050100	1/2"-100	1	
RF0500050120	1/2"-120	1	
RF0500050150	1/2"-150	1	
RF0500050200	1/2"-200	1	
RF0500050250	1/2"-250	1	
RF0500070050	3/4"-50	1	
RF0500070060	3/4"-60	1	
RF0500070070	3/4"-70	1	
RF0500070080	3/4"-80	1	
RF0500070090	3/4"-90	1	
RF0500070100	3/4"-100	1	
RF0500070120	3/4"-120	1	
RF0500070150	3/4"-150	1	
RF0500070200	3/4"-200	1	
RF0500070250	3/4"-250	1	
RF0500100050	1"-50	1	
RF0500100060	1"-60	1	
RF0500100070	1"-70	1	
RF0500100080	1"-80	1	
RF0500100090	1"-90	1	
RF0500100100	1"-100	1	
RF0500100120	1"-120	1	
RF0500100150	1"-150	1	
RF0500100200	1"-200	1	
RF0500100250	1"-250	1	

Misure diverse su richiesta - Différentes tailles sur demande

Sistemi a saldare

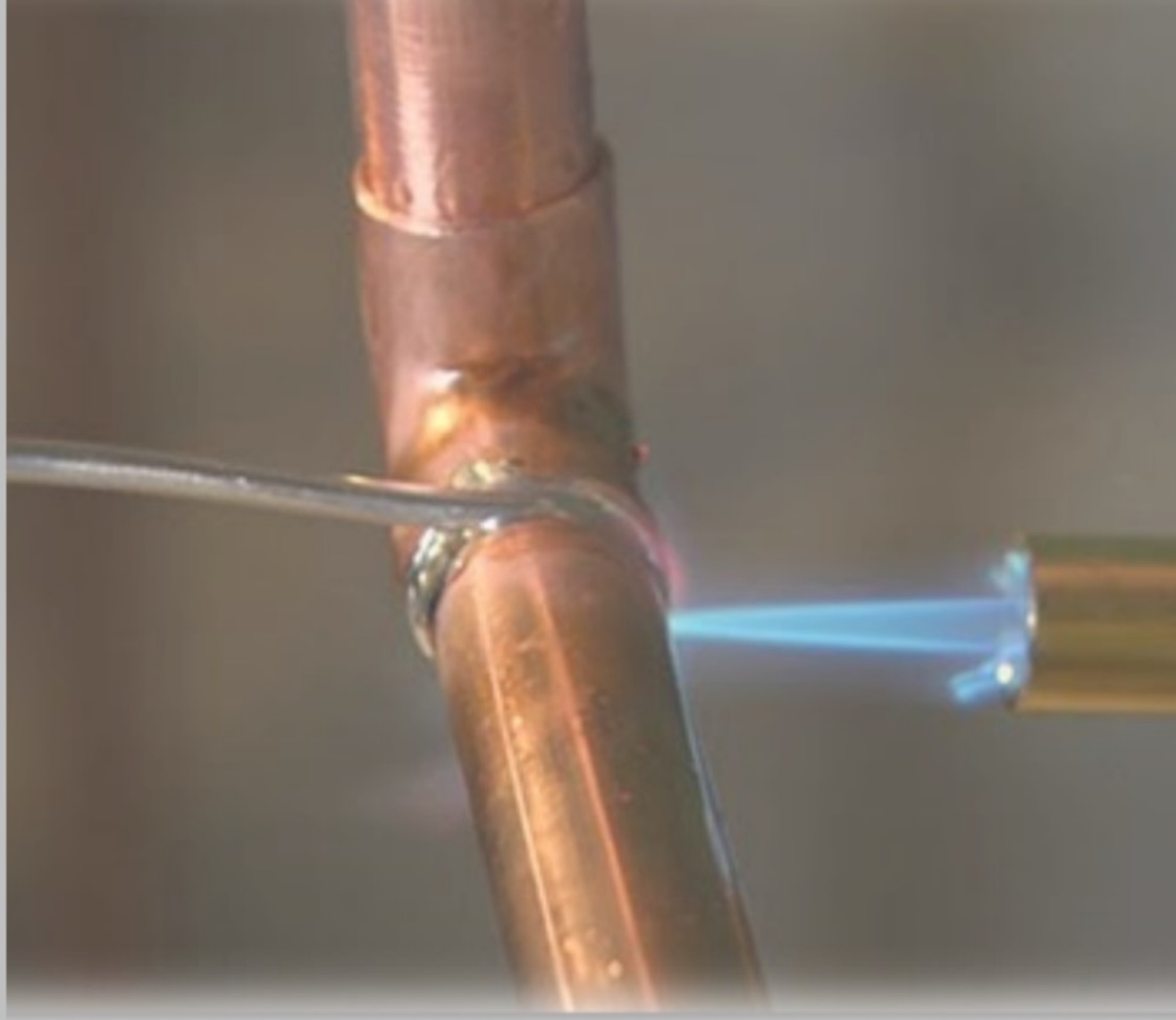

IT: Raccordi a saldare per tubazioni rame (RRS)

FR: Raccords à souder pour tube cuivre (RRS)

RRS 130



IT: Tee a saldare
FR: Tee à souder

Codice	Misura	Box	€
<u>RRS013000120</u>	12	10	
<u>RRS013000140</u>	14	10	
<u>RRS013000150</u>	15	10	
<u>RRS013000160</u>	16	10	
<u>RRS013000180</u>	18	10	
<u>RRS013000220</u>	22	5	
<u>RRS013000280</u>	28	5	
<u>RRS013000350</u>	35	5	

RRS 131



IT: Tee a saldare ridotto
FR: Tee à souder réduit

Codice	Misura	Box	€
<u>RRS0131014100</u>	14-10-14	10	
<u>RRS0131014120</u>	14-12-14	10	
<u>RRS0131015100</u>	15-10-15	10	
<u>RRS0131015120</u>	15-12-15	10	
<u>RRS0131016120</u>	16-12-16	10	
<u>RRS0131016140</u>	16-14-16	10	
<u>RRS0131018120</u>	18-12-18	10	
<u>RRS0131018140</u>	18-14-18	10	
<u>RRS0131018150</u>	18-15-18	10	
<u>RRS0131018160</u>	18-16-18	10	
<u>RRS0131022120</u>	22-12-22	5	
<u>RRS0131022140</u>	22-14-22	5	
<u>RRS0131022150</u>	22-15-22	5	
<u>RRS0131022180</u>	22-18-22	5	
<u>RRS0131028150</u>	28-15-28	5	
<u>RRS0131028160</u>	28-16-28	5	
<u>RRS0131028180</u>	28-18-28	5	
<u>RRS0131028220</u>	28-22-28	5	
<u>RRS0131035220</u>	35-22-35	5	
<u>RRS0131035280</u>	35-28-35	5	

RRS 90

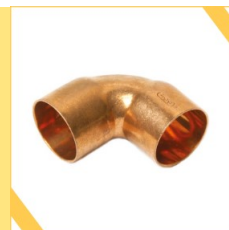

IT: Curva a saldare
FR: Coude à souder

Codice	Misura	Box	€
<u>RRS009000120</u>	12	10	
<u>RRS009000140</u>	14	10	
<u>RRS009000150</u>	15	10	
<u>RRS009000160</u>	16	10	
<u>RRS009000180</u>	18	10	
<u>RRS009000220</u>	22	5	
<u>RRS009000280</u>	28	5	
<u>RRS009000350</u>	35	5	

RRS 92



IT: Curva a saldare maschio femmina
FR: Coude à souder male femelle

Codice	Misura	Box	€
<u>RRS009200120</u>	12	10	
<u>RRS009200140</u>	14	10	
<u>RRS009200150</u>	15	10	
<u>RRS009200160</u>	16	10	
<u>RRS009200180</u>	18	10	
<u>RRS009200220</u>	22	5	
<u>RRS009200280</u>	28	5	
<u>RRS009200350</u>	35	5	

RRS 120



IT: Curva a saldare 45°
FR: Coude à souder 45°

Codice	Misura	Box	€
<u>RRS012000220</u>	22	5	
<u>RRS012000280</u>	28	5	
<u>RRS012000350</u>	35	5	

RRS 121



IT: Curva a saldare 45° M/F
FR: Coude à souder 45° M/F

Codice	Misura	Box	€
<u>RRS012100220</u>	22	5	
<u>RRS012100280</u>	28	5	
<u>RRS012100350</u>	35	5	

Prezzi Netti a richiesta

IT: Raccordi a saldare per tubazioni rame (RRS)

FR: Raccords à souder pour tube cuivre (RRS)

RRS 271



IT: Raccordo diritto maschio saldare
FR: Mamelon male à souder

Codice	Misura	Box	€
RRS027103120	3/8"-12	10	
RRS027103140	3/8"-14	10	
RRS027105120	1/2"-12	10	
RRS027105140	1/2"-14	10	
RRS027105150	1/2"-15	10	
RRS027105160	1/2"-16	10	
RRS027105180	1/2"-18	10	
RRS027105220	1/2"-22	10	
RRS027107160	3/4"-16	10	
RRS027107180	3/4"-18	10	
RRS027107220	3/4"-22	10	
RRS027107280	3/4"-28	10	
RRS027110220	1"-22	10	
RRS027110280	1"-28	10	

RRS 280



IT: Raccordo diritto femmina saldare
FR: Manchon femelle à souder

Codice	Misura	Box	€
RRS028003120	3/8"-12	10	
RRS028003140	3/8"-14	10	
RRS028005120	1/2"-12	10	
RRS028005140	1/2"-14	10	
RRS028005150	1/2"-15	10	
RRS028005160	1/2"-16	10	
RRS028005180	1/2"-18	10	
RRS280007160	3/4"-16	10	
RRS280007180	3/4"-18	10	
RRS280007220	3/4"-22	10	
RRS280010220	1"-22	10	
RRS280010280	1"-28	10	
RRS280012350	1"1/4-35	5	

RRS 261



IT: Curva maschio a saldare
FR: Coude male à souder

Codice	Misura	Box	€
RRS026103120	3/8"-12	10	
RRS026103140	3/8"-14	10	
RRS026105120	1/2"-12	10	
RRS026105140	1/2"-14	10	
RRS026105150	1/2"-15	10	
RRS026105160	1/2"-16	10	
RRS026105180	1/2"-18	10	
RRS026105220	1/2"-22	10	
RRS026107160	3/4"-16	10	
RRS026107180	3/4"-18	10	
RRS026107220	3/4"-22	10	
RRS026107280	3/4"-28	10	
RRS026110220	1"-22	10	
RRS026110280	1"-28	10	

RRS 262



IT: Curva femmina a saldare
FR: Coude femelle à souder

Codice	Misura	Box	€
RRS026203120	3/8"-12	10	
RRS026203140	3/8"-14	10	
RRS026205120	1/2"-12	10	
RRS026205140	1/2"-14	10	
RRS026205150	1/2"-15	10	
RRS026205160	1/2"-16	10	
RRS026205180	1/2"-18	10	
RRS026205220	1/2"-22	10	
RRS026207160	3/4"-16	10	
RRS026207180	3/4"-18	10	
RRS026207220	3/4"-22	10	
RRS026207280	3/4"-28	10	
RRS026210220	1"-22	10	
RRS026210280	1"-28	10	

RRS 252



IT: Tee femmina a saldare
FR: Tee femelle à souder

Codice	Misura	Box	€
RRS025203120	3/8"-12	10	
RRS025205120	1/2"-12	10	
RRS025205140	1/2"-14	10	
RRS025205150	1/2"-15	10	
RRS025205160	1/2"-16	10	
RRS025205180	1/2"-18	10	
RRS025207160	3/4"-16	10	
RRS025207180	3/4"-18	10	
RRS025207220	3/4"-22	10	

RRS 126



IT: Raccordo diritto 3 pezzi saldare
FR: Union femelle à souder

Codice	Misura	Box	€
RRS012603120	3/8"-12	10	
RRS012605120	1/2"-12	10	
RRS012605140	1/2"-14	10	
RRS012605150	1/2"-15	10	
RRS012605160	1/2"-16	10	
RRS012605180	1/2"-18	10	
RRS012607160	3/4"-16	10	
RRS012607180	3/4"-18	10	
RRS012607220	3/4"-22	10	

Prezzi Netti a richiesta



IT: Raccordi a saldare per tubazioni ferro EN 10253-1 (RS)

FR: Raccords à souder pour tube acier EN 10253-1 (RS)

RS 250



IT: Tee a saldare
FR: Tee à souder

Codice	Misura	Box	€
RS0250001000	33.7	10	<u>12.42</u>
RS0250001200	42.4	10	<u>12.89</u>
RS0250001500	48.3	10	<u>16.41</u>
RS0250002000	60.3	10	<u>21.36</u>
RS0250002500	76.1	5	<u>38.03</u>
RS0250003000	88.9	2	<u>48.19</u>
RS0250004000	114.3	1	<u>74.98</u>
RS0250005000	139.7	1	<u>119.22</u>
RS0250006000	168.3	1	<u>156.47</u>
RS0250008000	219.1	1	<u>263.22</u>

RS 260S



IT: Curva a saldare con saldatura
FR: Coude à souder

Codice	Misura	Box	€
RS0260S02000	60.3	10	<u>4.34</u>
RS0260S02500	76.1	5	<u>6.55</u>
RS0260S03000	88.9	2	<u>12.36</u>
RS0260S04000	114.3	1	<u>22.00</u>

RS 288



IT: Fondo bombato a saldare
FR: Bouchon à souder

Codice	Misura	Box	€
RS0288001000	33.7	30	<u>1.09</u>
RS0288001200	42.4	20	<u>1.17</u>
RS0288001500	48.3	20	<u>1.35</u>
RS0288002000	60.3	10	<u>2.04</u>
RS0288002500	76.1	10	<u>2.43</u>
RS0288003000	88.9	5	<u>2.95</u>
RS0288004000	114.3	2	<u>4.69</u>
RS0288005000	139.7	1	<u>8.55</u>
RS0288006000	168.3	1	<u>13.42</u>
RS0288008000	219.1	1	<u>24.40</u>
RS0288010000	273.0	1	<u>36.73</u>
RS0288012000	324.0	1	<u>40.64</u>

RS 294



IT: Riduzione concentrica a saldare
FR: Reduction concentrique

Codice	Misura	Box	€
RS0294010070	33.7-26.9	20	<u>5.38</u>
RS0294012070	42.4-26.9	20	<u>6.21</u>
RS0294012100	42.4-33.7	10	<u>5.38</u>
RS0294015070	48.3-26.9	10	<u>8.73</u>
RS0294015100	48.3-33.7	10	<u>6.99</u>
RS0294015120	48.3-42.4	5	<u>5.86</u>
RS0294020100	60.3-33.7	5	<u>8.55</u>
RS0294020120	60.3-42.4	5	<u>8.21</u>
RS0294020150	60.3-48.3	1	<u>6.21</u>
RS0294025120	76.1-42.4	1	<u>9.38</u>
RS0294025150	76.1-48.3	1	<u>8.47</u>
RS0294025200	76.1-60.3	1	<u>7.60</u>
RS0294030150	88.9-48.3	1	<u>11.11</u>
RS0294030200	88.9-60.3	1	<u>10.72</u>
RS0294030250	88.9-76.1	1	<u>8.99</u>
RS0294040200	114.3-60.3	1	<u>19.45</u>
RS0294040250	114.3-76.1	1	<u>18.06</u>
RS0294040300	114.3-88.9	1	<u>17.45</u>
RS0294050250	139.7-76.1	1	<u>29.13</u>
RS0294050300	139.7-88.9	1	<u>29.13</u>
RS0294050400	139.7-114.3	1	<u>27.31</u>
RS0294060300	168.3-88.9	1	<u>40.51</u>
RS0294060400	168.3-114.3	1	<u>42.50</u>
RS0294060500	168.3-139.7	1	<u>32.60</u>
RS0294080400	219.1-114.3	1	<u>86.66</u>
RS0294080500	219.1-139.7	1	<u>61.91</u>
RS0294080600	219.1-168.3	1	<u>61.91</u>

RS 270F



IT: Manicotto a saldare
FR: Manchon à souder

Codice	Misura	Box	€
RS0270F00500	1/2"	10	<u>1.04</u>
RS0270F00700	3/4"	10	<u>1.65</u>
RS0270F01000	1"	10	<u>2.08</u>
RS0270F01200	1 1/4"	10	<u>3.26</u>
RS0270F01500	1 1/2"	10	<u>4.12</u>
RS0270F02000	2"	5	<u>4.82</u>
RS0270F02500	2 1/2"	1	<u>7.60</u>
RS0270F03000	3"	1	<u>10.42</u>

RS 529



IT: Tronchetto a saldare
FR: Bobine male à souder

Codice	Misura	Box	€
RRS0529007150	3/4"-150	10	<u>2.52</u>
RRS0529010150	1"-150	10	<u>2.84</u>
RRS0529012150	1 1/4"-150	10	<u>3.67</u>
RRS0529015150	1 1/2"-150	10	<u>4.03</u>
RRS0529020150	2"-150	10	<u>5.98</u>
RRS0529025150	2 1/2"-150	10	<u>6.88</u>
RRS0529030150	3"-150	10	<u>9.86</u>
RRS0529040150	4"-150	10	<u>15.12</u>

Valvole e rubinetterie



IT: Valvole e rubinetteria a sfera (VS)

FR: Robinets à boisseau spherique (VS)

VS 137



IT: Valvola a sfera passaggio standard F/F
FR: Robinet à boisseau passage standard F/F

Codice	Misura	Box	€
<u>VS0137005ARN</u>	1/2"	160	<u>5.53</u>
<u>VS0137007ARN</u>	3/4"	120	<u>8.31</u>
<u>VS0137010ARN</u>	1"	60	<u>11.64</u>

VS 137P



IT: Valvola a sfera passaggio standard F/F maniglia farfalla
FR: Robinet à boisseau passage standard F/F manette papillon

Codice	Misura	Box	€
<u>VS0137P05PRN</u>	1/2"	160	<u>5.49</u>
<u>VS0137P07PRN</u>	3/4"	120	<u>8.31</u>
<u>VS0137P10PRN</u>	1"	60	<u>11.60</u>

VS 137M



IT: Valvola a sfera passaggio standard M/F
FR: Robinet à boisseau passage standard M/F

Codice	Misura	Box	€
<u>VS0137M05ARN</u>	1/2"	160	<u>5.86</u>
<u>VS0137M07ARN</u>	3/4"	120	<u>8.65</u>
<u>VS0137M10ARN</u>	1"	60	<u>11.93</u>

VS 137MP



IT: Valvola a sfera passaggio standard M/F maniglia farfalla
FR: Robinet à boisseau passage standard M/F manette papillon

Codice	Misura	Box	€
<u>VS0137M05PRN</u>	1/2"	160	<u>5.86</u>
<u>VS0137M07PRN</u>	3/4"	120	<u>8.65</u>
<u>VS0137M10PRN</u>	1"	60	<u>11.93</u>

VS 138



IT: Valvola a sfera passaggio integrale a squadra M/F con codulo
FR: Robinet à boisseau èquerre passage integrale M/F avec douille

Codice	Misura	Box	€
<u>VS0138005PRN</u>	1/2"	90	<u>6.61</u>
<u>VS0138007PRN</u>	3/4"	80	<u>8.98</u>
<u>VS0138010PRN</u>	1"	40	<u>12.47</u>

VS 138P



IT: Valvola a sfera passaggio integrale diritta M/F con codulo
FR: Robinet à boisseau droites passage integrale M/F avec douille

Codice	Misura	Box	€
<u>VS0138005PRN</u>	1/2"	120	<u>6.61</u>
<u>VS0138007PRN</u>	3/4"	90	<u>8.98</u>
<u>VS0138010PRN</u>	1"	60	<u>12.47</u>

IT: Valvole e rubinetteria a sfera (VS)

FR: Robinets à boisseau spherique (VS)

VS 141



IT: Valvola a sfera passaggio integrale F/F
FR: Robinet à boisseau passage integrale F/F

Codice	Misura	Box	€
VS0141003ARN	3/8"	160	<u>6.53</u>
VS0141005ARN	1/2"	160	<u>6.53</u>
VS0141007ARN	3/4"	120	<u>9.94</u>
VS0141010ARN	1"	60	<u>15.38</u>
VS0141012ARN	1"1/4	48	<u>24.03</u>
VS0141015ARN	1"1/2	24	<u>34.63</u>
VS0141020ARN	2"	12	<u>53.71</u>
VS0141025ARN	2"1/2	6	<u>117.39</u>
VS0141030ARN	3"	2	<u>224.60</u>
VS0141040ARN	4"	1	<u>386.97</u>

VS 141P



IT: Valvola a sfera passaggio integrale F/F maniglia farfalla
FR: Robinet à boisseau passage integrale F/F manette papillon

Codice	Misura	Box	€
VS0141003PRN	3/8"	160	<u>6.53</u>
VS0141005PRN	1/2"	160	<u>6.48</u>
VS0141007PRN	3/4"	120	<u>9.94</u>
VS0141010PRN	1"	60	<u>15.34</u>

VS 147



IT: Valvola a sfera passaggio integrale M/F
FR: Robinet à boisseau passage integrale M/F

Codice	Misura	Box	€
VS0147005ARN	1/2"	160	<u>6.82</u>
VS0147007ARN	3/4"	120	<u>10.48</u>
VS0147010ARN	1"	60	<u>16.17</u>
VS0147012ARN	1"1/4	48	<u>25.27</u>
VS0147015ARN	1"1/2	24	<u>36.25</u>
VS0147020ARN	2"	12	<u>56.29</u>

VS 147P



IT: Valvola a sfera passaggio integrale M/F maniglia farfalla
FR: Robinet à boisseau passage integrale M/F manette papillon

Codice	Misura	Box	€
VS0147005PRN	1/2"	160	<u>6.78</u>
VS0147007PRN	3/4"	120	<u>10.48</u>
VS0147010PRN	1"	60	<u>16.13</u>

VS 148



IT: Valvola a sfera passaggio integrale a squadra M/M
FR: Robinet à boisseau èquerre passage integrale M/M

Codice	Misura	Box	€
VS0148005ARN	1/2"	160	<u>7.19</u>
VS0148007ARN	3/4"	120	<u>11.02</u>
VS0148010ARN	1"	60	<u>16.96</u>

VS 148P



IT: Valvola a sfera passaggio integrale diritta M/M
FR: Robinet à boisseau droites passage integrale M/M manette papillon

Codice	Misura	Box	€
VS0148P05PRN	1/2"	120	<u>7.19</u>
VS0148P07PRN	3/4"	90	<u>11.02</u>
VS0148P10PRN	1"	60	<u>16.96</u>

IT: Valvole e rubinetteria a sfera (VS)

FR: Robinets à boisseau spherique (VS)

VS 144



IT: Valvola a sfera passaggio integrale F/F con spurgo
FR: Robinet à boisseau passage integrale F/F à purge

Codice	Misura	Box	€
VS0144005ARN	1/2"	80	<u>10.85</u>
VS0144007ARN	3/4"	60	<u>15.26</u>
VS0144010ARN	1"	40	<u>21.03</u>

VS 146A



IT: Valvola a sfera passaggio integrale a squadra M/F con codulo
FR: Robinet à boisseau èquerre passage integrale M/F avec douille

Codice	Misura	Box	€
VS0146A05PRN	1/2"	90	<u>11.72</u>
VS0146A07PRN	3/4"	80	<u>25.15</u>
VS0146A10PRN	1"	40	<u>36.37</u>

VS 146B



IT: Valvola a sfera passaggio integrale diritta M/F con codulo
FR: Robinet à boisseau droites passage integrale M/F avec douille

Codice	Misura	Box	€
VS0146B05PRN	1/2"	120	<u>10.31</u>
VS0146B07PRN	3/4"	90	<u>15.38</u>
VS0146B10PRN	1"	60	<u>23.36</u>
VS0146B12PRN	1"1/4	36	<u>36.83</u>

VS 720



IT: Valvola a sfera contatore dritta femmina calotta libera
FR: Robinet avant compteur d'eau droites femelle écrou prisonnier

Codice	Misura	Box	€
VS0720050700	1/2" x 3/4"	10	<u>13.52</u>
VS0720070700	3/4" x 3/4"	10	<u>14.27</u>

VS 721



IT: Valvola a sfera contatore dritta maschio calotta libera
FR: Robinet avant compteur d'eau droites male écrou prisonnier

Codice	Misura	Box	€
VS0721050700	1/2" x 3/4"	10	<u>13.73</u>
VS0721070700	3/4" x 3/4"	10	<u>14.36</u>

VS 722



IT: Valvola a sfera contatore a squadra femmina calotta libera
FR: Robinet avant compteur d'eau èquerre femelle écrou prisonnier

Codice	Misura	Box	€
VS0722050700	1/2" x 3/4"	10	<u>16.48</u>
VS0722070700	3/4" x 3/4"	10	<u>17.89</u>

IT: Valvole e rubinetteria a sfera (VS)

FR: Robinets à boisseau spherique (VS)

VA 600



IT: Valvola a sfera F/F a incasso con cappuccio cromato

FR: Robinet à boisseau passage integrale F/F à encasser

Codice	Misura	Box	€
<u>VA060000500N</u>	<u>1/2"</u>	<u>10</u>	<u>19.79</u>
<u>VA060000700N</u>	<u>3/4"</u>	<u>5</u>	<u>27.73</u>

VSX 141



IT: Valvola a sfera passaggio integrale acciaio INOX F/F

FR: Robinet à boisseau passage integrale acier inoxydable F/F

Codice	Misura	Box	€
<u>VSX141000200</u>	<u>1/4"</u>	<u>20</u>	<u>12.34</u>
<u>VSX141000300</u>	<u>3/8"</u>	<u>20</u>	<u>13.57</u>
<u>VSX141000500</u>	<u>1/2"</u>	<u>20</u>	<u>14.81</u>
<u>VSX141000700</u>	<u>3/4"</u>	<u>20</u>	<u>20.56</u>
<u>VSX141001000</u>	<u>1"</u>	<u>15</u>	<u>28.38</u>
<u>VSX141001200</u>	<u>1"1/4</u>	<u>15</u>	<u>43.18</u>
<u>VSX141001500</u>	<u>1"1/2</u>	<u>10</u>	<u>57.58</u>
<u>VSX141002000</u>	<u>2"</u>	<u>4</u>	<u>92.53</u>
<u>VSX141002500</u>	<u>2"1/2</u>	<u>2</u>	<u>176.84</u>
<u>VSX141003000</u>	<u>3"</u>	<u>1</u>	<u>270.61</u>

VSX 142



IT: Valvola a sfera 3 pezzi passaggio integrale acciaio INOX F/F

FR: Robinet à boisseau 3 pièces passage integrale acier inoxydable F/F

Codice	Misura	Box	€
<u>VSX142000500</u>	<u>1/2"</u>	<u>20</u>	<u>27.51</u>
<u>VSX142000700</u>	<u>3/4"</u>	<u>20</u>	<u>35.64</u>
<u>VSX142001000</u>	<u>1"</u>	<u>15</u>	<u>48.76</u>
<u>VSX142001200</u>	<u>1"1/4</u>	<u>15</u>	<u>80.55</u>
<u>VSX142001500</u>	<u>1"1/2</u>	<u>10</u>	<u>101.65</u>
<u>VSX142002000</u>	<u>2"</u>	<u>4</u>	<u>142.85</u>

IT: Valvole e rubinetteria a sfera (VS, PI)

FR: Robinets à boisseau spherique (VS, PI)

PI 136



IT: Rubinetto da giardino
FR: Robinet d'arrosage

Codice	Misura	Box	€
<u>PI013600500N</u>	<u>1/2" - 3/4"</u>	<u>25</u>	<u>6.78</u>
<u>PI013600700N</u>	<u>3/4" - 1"</u>	<u>20</u>	<u>8.89</u>

PI 134



IT: Rubinetto da giardino con maniglia luchettabile
FR: Robinet d'arrosage poignée plombable

Codice	Misura	Box	€
<u>PI013400500N</u>	<u>1/2" - 3/4"</u>	<u>25</u>	<u>9.40</u>

PI 96



IT: Scarico caldaia con portagomma attacco maschio
FR: Robinet de vidange male

Codice	Misura	Box	€
<u>PI0096005000</u>	<u>1/2"</u>	<u>10</u>	<u>5.51</u>

PI 299



IT: Rubinetto lavatrice con rosetta
FR: Robinet machine à laver avec rosette

Codice	Misura	Box	€
<u>PI029900505C</u>	<u>1/2" - 1/2"</u>	<u>20</u>	<u>7.16</u>
<u>PI029900507C</u>	<u>1/2" - 3/4"</u>	<u>15</u>	<u>7.96</u>

PI 99F



IT: Minivalvola F/F
FR: Vanne mignon femelle femelle

Codice	Misura	Box	€
<u>PI0099F00200</u>	<u>1/4"</u>	<u>30</u>	<u>4.74</u>
<u>PI0099F00300</u>	<u>3/8"</u>	<u>25</u>	<u>4.74</u>
<u>PI0099F00500</u>	<u>1/2"</u>	<u>20</u>	<u>5.80</u>

PI 99M



IT: Minivalvola M/F
FR: Vanne mignon male femelle

Codice	Misura	Box	€
<u>PI0099M00200</u>	<u>1/4"</u>	<u>30</u>	<u>3.90</u>
<u>PI0099M00300</u>	<u>3/8"</u>	<u>25</u>	<u>3.94</u>
<u>PI0099M00500</u>	<u>1/2"</u>	<u>20</u>	<u>4.32</u>

IT: Valvole e rubinetteria varia (PI)

FR: Robinets et vannes (PI)

PI 650



IT: Valvola di ritengno con disco in Nylon
FR: Clapet antiretour avec obturateur en Nylon

Codice	Misura	Box	€
PI0650005000	1/2"	30	5.08
PI0650007000	3/4"	25	6.90
PI0650010000	1"	15	10.21
PI0650012000	1 1/4"	10	14.23
PI0650015000	1 1/2"	10	19.86
PI0650020000	2"	5	30.16

PI 650S



IT: Valvola di ritengno pesante con otturatore in ottone
FR: Clapet antiretour avec obturateur en laiton

Codice	Misura	Box	€
PI0650S05000	1/2"	30	7.96
PI0650S07000	3/4"	25	11.10
PI0650S10000	1"	15	18.47
PI0650S12000	1 1/4"	10	30.37
PI0650S15000	1 1/2"	10	40.24
PI0650S20000	2"	5	62.64
PI0650S25000	2 1/2"	1	117.70
PI0650S30000	3"	1	187.58
PI0650S40000	4"	1	248.06

PI 400



IT: Valvola a clapet sede in metallo
FR: Vannè à clapet avec siège metal

Codice	Misura	Box	€
PI0400005000	1/2"	20	8.98
PI0400007000	3/4"	15	12.37
PI0400010000	1"	10	17.24
PI0400012000	1 1/4"	5	23.72
PI0400015000	1 1/2"	5	35.20
PI0400020000	2"	1	48.49
PI0400025000	2 1/2"	1	71.07
PI0400030000	3"	1	111.22
PI0400040000	4"	1	182.29

PI 450



IT: Valvola di fondo con filtro in ottone
FR: Vanne crepine avec filtre en laiton

Codice	Misura	Box	€
PI0450007000	3/4"	20	10.00
PI0450010000	1"	15	12.11
PI0450012000	1 1/4"	10	19.02
PI0450015000	1 1/2"	5	23.76
PI0450020000	2"	1	38.03
PI0450025000	2 1/2"	1	60.18
PI0450030000	3"	1	82.00
PI0450040000	4"	1	142.01

PI 656



IT: Filtro ad impurità ad Y ottone
FR: Filtre Y Laiton

Codice	Misura	Box	€
PI0656005000	1/2"	25	5.93
PI0656007000	3/4"	20	9.70
PI0656010000	1"	15	12.96
PI0656012000	1 1/4"	10	23.97
PI0656015000	1 1/2"	5	30.11
PI0656020000	2"	1	53.66
PI0656025000	2 1/2"	1	85.13
PI0656030000	3"	1	168.57
PI0656040000	4"	1	350.39

VA 231



IT: Saracinesca filettata F/FPN 16
FR: Vanne à passage direct FE/FE PN 16

Codice	Misura	Box	€
VA0231005000	1/2"	20	8.77
VA0231007000	3/4"	15	12.28
VA0231010000	1"	10	15.92
VA0231012000	1 1/4"	5	22.15
VA0231015000	1 1/2"	5	30.54
VA0231020000	2"	5	45.87
VA0231025000	2 1/2"	1	70.60
VA0231030000	3"	1	87.93
VA0231040000	4"	1	154.93

IT: Valvole e rubinetteria varia (PI)

FR: Robinets et vannes (PI)

VA 110



IT: Valvola di sfogo aria automatica
FR: Air purgeur automatique

Codice	Misura	Box	€
VA0110000300	3/8"	10	7.07
VA0110000500	1/2"	10	7.07
VA0110000700	3/4"	10	7.84
VA0110001000	1"	10	10.93

VA 63



IT: Valvola di sfogo aria automatica
attacco 90°
FR: Air purgeur automatique 90°

Codice	Misura	Box	€
VA0063000030	3/8"	10	6.86
VA0063000050	1/2"	10	6.86

VAX 110



IT: Valvola di sfogo aria automatica
per impianti solari
FR: Air purgeur automatique pour
solaire

Codice	Misura	Box	€
VAX0110000300	3/8"	10	10.59
VAX0110000500	1/2"	10	10.59

VA 60



IT: Valvola di sicurezza attacco fem-
mina (3-6 bar)
FR: Vanne de suretè femelle (3-6 bar)

Codice	Misura	Box	€
VA0060000503	1/2"- 3b	10	6.14
VA0060000506	1/2"- 6b	10	6.14
VA0060000703	3/4"- 3b	10	9.15
VA0060000706	3/4"- 6b	10	9.15
VA0060001003	1"- 3b	10	14.23
VA0060001006	1"- 6b	10	14.23

VA 61



IT: Valvola di sicurezza attacco ma-
schio (3-6 bar)
FR: Vanne de suretè male (3-6 bar)

Codice	Misura	Box	€
VA0061000503	1/2"- 3b	10	6.40
VA0061000506	1/2"- 6b	10	6.40

VI 200



IT: Valvola di bilanciamento VI200-
9500
FR: Vanne d'équilibrage VI200-9500

Codice	Misura	Box	€
VI0200000150	1/2"	10	94.59
VI0200000200	3/4"	10	101.38
VI0200000250	1"	10	117.11
VI0200000320	1 1/4"	5	141.88
VI0200000400	1 1/2"	5	175.66
VI0200000500	2"	1	247.73

IT: Valvole industriali (VI)

FR: Robinetterie industrielle (VI)

VI 235T



IT: Valvola a farfalla WAFER PN 16
FR: Vanne Papillon WAFER PN 16

Codice	Misura	Box	€
VI0235T04000	DN 40	1	<u>52.33</u>
VI0235T05000	DN 50	1	<u>52.33</u>
VI0235T06500	DN 65	1	<u>63.18</u>
VI0235T08000	DN 80	1	<u>67.93</u>
VI0235T10000	DN 100	1	<u>89.18</u>
VI0235T12500	DN 125	1	<u>128.08</u>
VI0235T15000	DN 150	1	<u>149.95</u>
VI0235T20000	DN 200	1	<u>220.54</u>
VI0235T25000	DN 250	1	<u>348.82</u>
VI0235T30000	DN 300	1	<u>485.62</u>

VI 255T



IT: Valvola a farfalla LUG PN 16
FR: Vanne Papillon LUG PN 16

Codice	Misura	Box	€
VI0255T04000	DN 40	1	<u>67.68</u>
VI0255T05000	DN 50	1	<u>67.68</u>
VI0255T06500	DN 65	1	<u>81.11</u>
VI0255T08000	DN 80	1	<u>93.03</u>
VI0255T10000	DN 100	1	<u>136.56</u>
VI0255T12500	DN 125	1	<u>181.60</u>
VI0255T15000	DN 150	1	<u>205.26</u>
VI0255T20000	DN 200	1	<u>298.46</u>
VI0255T25000	DN 250	1	<u>444.76</u>
VI0255T30000	DN 300	1	<u>643.68</u>

VIK 235T



IT: Valvola a farfalla WAFER PN 16
lente INOX
FR: Vanne Papillon WAFER PN 16
disque en acier INOX

Codice	Misura	Box	€
VIK235T04000	DN 40	1	<u>59.70</u>
VIK235T05000	DN 50	1	<u>59.70</u>
VIK235T06500	DN 65	1	<u>74.89</u>
VIK235T08000	DN 80	1	<u>83.69</u>
VIK235T10000	DN 100	1	<u>122.06</u>
VIK235T12500	DN 125	1	<u>170.21</u>
VIK235T15000	DN 150	1	<u>204.12</u>
VIK235T20000	DN 200	1	<u>368.19</u>
VIK235T25000	DN 250	1	<u>582.83</u>
VIK235T30000	DN 300	1	<u>911.67</u>

VIK 255T



IT: Valvola a farfalla LUG PN 16 lente
INOX
FR: Vanne Papillon LUG PN 16 disque
en acier INOX

Codice	Misura	Box	€
VIK255T04000	DN 40	1	<u>82.34</u>
VIK255T05000	DN 50	1	<u>82.34</u>
VIK255T06500	DN 65	1	<u>98.15</u>
VIK255T08000	DN 80	1	<u>116.29</u>
VIK255T10000	DN 100	1	<u>170.66</u>
VIK255T12500	DN 125	1	<u>233.27</u>
VIK255T15000	DN 150	1	<u>305.30</u>
VIK255T20000	DN 200	1	<u>465.27</u>
VIK255T25000	DN 250	1	<u>802.30</u>
VIK255T30000	DN 300	1	<u>1247.80</u>

VI 44



IT: Saracinesca in ghisa a cuneo gom-
mato PN 16
FR: Vanne à opercule caoutchouc
PN 16

Codice	Misura	Box	€
VI0044004000	DN 40	1	<u>135.94</u>
VI0044005000	DN 50	1	<u>142.21</u>
VI00440065000	DN 65	1	<u>174.96</u>
VI00440080000	DN 80	1	<u>220.13</u>
VI00441000000	DN 100	1	<u>270.94</u>
VI00441250000	DN 125	1	<u>376.99</u>
VI00441500000	DN 150	1	<u>498.11</u>
VI00442000000	DN 200	1	<u>747.31</u>
VI00442250000	DN 250	1	<u>1118.61</u>
VI00442300000	DN 300	1	<u>1683.55</u>

VI 43



IT: Valvola a globo Flusso Avviato PN
16
FR: Vanne a soufflet fonte PN 16

Codice	Misura	Box	€
VI0043002000	DN 20	1	<u>122.84</u>
VI0043002500	DN 25	1	<u>141.27</u>
VI0043003200	DN 32	1	<u>171.97</u>
VI0043004000	DN 40	1	<u>184.10</u>
VI0043005000	DN 50	1	<u>240.52</u>
VI0043006500	DN 65	1	<u>325.52</u>
VI0043008000	DN 80	1	<u>423.80</u>
VI0043010000	DN 100	1	<u>620.34</u>
VI0043012500	DN 125	1	<u>866.02</u>
VI0043015000	DN 150	1	<u>1136.26</u>

IT: Valvole industriali (VI)

FR: Robinetterie industrielle (VI)

VI 355T



IT: Valvola a farfalla LUG Gas
FR: Vanne Papillon LUG Gaz

Codice	Misura	Box	€
VI0355T04000	DN 40	1	<u>171.12</u>
VI0355T05000	DN 50	1	<u>172.26</u>
VI0355T06500	DN 65	1	<u>194.33</u>
VI0355T08000	DN 80	1	<u>221.72</u>
VI0355010000	DN 100	1	<u>255.83</u>
VI0355012500	DN 125	1	<u>311.97</u>
VI0355015000	DN 150	1	<u>341.08</u>
VI0355020000	DN 200	1	<u>539.84</u>

VI 122



IT: Valvola ritegno doppio battente
PN 16
FR: Clapet double battant entre brides
PN 16

Codice	Misura	Box	€
VI0122004000	DN 40	1	<u>52.93</u>
VI0122005000	DN 50	1	<u>55.77</u>
VI0122006500	DN 65	1	<u>65.31</u>
VI0122008000	DN 80	1	<u>86.64</u>
VI0122010000	DN 100	1	<u>107.98</u>
VI0122012500	DN 125	1	<u>146.01</u>
VI0122015000	DN 150	1	<u>214.44</u>
VI0122020000	DN 200	1	<u>379.53</u>
VI0122025000	DN 250	1	<u>548.19</u>
VI0122030000	DN 300	1	<u>742.52</u>

VI 69F



IT: Valvola di ritegno a palla flangiata
PN 16
FR: Clapet à boule entre brides PN 16

Codice	Misura	Box	€
VI0069F05000	DN 50	1	<u>154.82</u>
VI0069F06500	DN 65	1	<u>203.26</u>
VI0069F08000	DN 80	1	<u>253.62</u>
VI0069F10000	DN 100	1	<u>331.87</u>
VI0069F12500	DN 125	1	<u>491.11</u>
VI0069F15000	DN 150	1	<u>632.13</u>
VI0069F20000	DN 200	1	<u>1250.87</u>
VI0069F25000	DN 250	1	<u>2447.61</u>
VI0069F30000	DN 300	1	<u>3114.22</u>

VI 69



IT: Valvola di ritegno a palla filettata
PN 16
FR: Clapet à boule fileté PN 16

Codice	Misura	Box	€
VI0069001000	1"	1	<u>63.39</u>
VI0069001200	1 1/4"	1	<u>68.18</u>
VI0069001500	1 1/2"	1	<u>81.52</u>
VI0069002000	2"	1	<u>121.08</u>
VI0069002500	2 1/2"	1	<u>173.90</u>
VI0069003000	3"	1	<u>237.08</u>

VI 280



IT: Filtro di impurità in ghisa PN 16
FR: Filtre à Y fonte PN 16

Codice	Misura	Box	€
VI0280004000	DN 40	1	<u>58.23</u>
VI0280005000	DN 50	1	<u>96.39</u>
VI0280006500	DN 65	1	<u>142.66</u>
VI0280008000	DN 80	1	<u>166.49</u>
VI0280010000	DN 100	1	<u>217.67</u>
VI0280012500	DN 125	1	<u>309.35</u>
VI0280015000	DN 150	1	<u>432.84</u>
VI0280020000	DN 200	1	<u>763.98</u>
VI0280025000	DN 250	1	<u>1289.57</u>
VI0280030000	DN 300	1	<u>1907.49</u>

VI 10G



IT: Giunto compensatore in gomma
PN 16
FR: Compenasteur elastomere à brides
PN 16

Codice	Misura	Box	€
VI0010G04000	DN 40	1	<u>49.50</u>
VI0010G05000	DN 50	1	<u>59.62</u>
VI0010G06500	DN 65	1	<u>74.93</u>
VI0010G08000	DN 80	1	<u>87.42</u>
VI0010G10000	DN 100	1	<u>100.24</u>
VI0010G12500	DN 125	1	<u>147.28</u>
VI0010G15000	DN 150	1	<u>187.62</u>
VI0010G20000	DN 200	1	<u>297.39</u>
VI0010G25000	DN 250	1	<u>412.49</u>
VI0010G30000	DN 300	1	<u>534.43</u>

VI 2278



IT: Flangia piana a saldare PN 16
FR: Bride plat à souder PN 16

Codice	Misura	Box	€
VI2278002500	DN 25	1	<u>6.62</u>
VI2278003200	DN 32	1	<u>10.68</u>
VI2278004000	DN 40	1	<u>12.41</u>
VI2278005000	DN 50	1	<u>15.61</u>
VI2278006500	DN 65	1	<u>18.58</u>
VI2278008000	DN 80	1	<u>20.50</u>
VI2278010000	DN 100	1	<u>24.08</u>
VI2278012500	DN 125	1	<u>29.91</u>
VI2278015000	DN 150	1	<u>39.31</u>
VI2278020000	DN 200	1	<u>53.42</u>

VI 2282



IT: Flangia a collarino a saldare PN 16
FR: Bride avec collier à souder PN 16

Codice	Misura	Box	€
VI02282002500	DN 25	1	<u>12.34</u>
VI02282003200	DN 32	1	<u>16.25</u>
VI02282004000	DN 40	1	<u>17.79</u>
VI02282005000	DN 50	1	<u>18.47</u>
VI02282006500	DN 65	1	<u>22.38</u>
VI02282008000	DN 80	1	<u>27.54</u>
VI02282010000	DN 100	1	<u>32.50</u>
VI02282012500	DN 125	1	<u>44.88</u>
VI02282015000	DN 150	1	<u>54.74</u>
VI02282020000	DN 200	1	<u>79.08</u>

VI 2290



IT: Valvola di ritegno a palla flangiata PN 16
FR: Clapet à boule entre bride PN 16

Codice	Misura	Box	€
VI2290000500	1/2"	1	<u>4.71</u>
VI2290000700	3/4"	1	<u>6.69</u>
VI2290001000	1"	1	<u>8.01</u>
VI2290001200	1 1/4"	1	<u>15.78</u>
VI2290001500	1 1/2"	1	<u>18.64</u>
VI2290002000	2"	1	<u>21.58</u>
VI2290002500	2 1/2"	1	<u>27.41</u>
VI2290003000	3"	1	<u>34.42</u>
VI2290004000	4"	1	<u>41.33</u>
VI2290005000	5"	1	<u>52.62</u>
VI2290006000	6"	1	<u>61.38</u>
VI2290008000	8"	1	<u>120.57</u>

VI 6093



IT: Flangia Cieca PN 16
FR: Bride aveugle PN 16

Codice	Misura	Box	€
VI6093005000	DN 50	1	<u>17.49</u>
VI6093006500	DN 65	1	<u>20.50</u>
VI6093008000	DN 80	1	<u>26.94</u>
VI6093010000	DN 100	1	<u>33.14</u>
VI6093012500	DN 125	1	<u>46.65</u>
VI6093015000	DN 150	1	<u>58.91</u>
VI6093020000	DN 200	1	<u>92.17</u>

GF



IT: Guarnizione in fibra sintetica e-sente amianto
FR: Joint torique en fibre sans amian-te

Codice	Misura	Box	€
VI00GF000025	DN 25	10	<u>0.68</u>
VI00GF000032	DN 32	10	<u>0.87</u>
VI00GF000040	DN 40	10	<u>1.05</u>
VI00GF000050	DN 50	10	<u>1.43</u>
VI00GF000065	DN 65	10	<u>1.99</u>
VI00GF000080	DN 80	10	<u>2.86</u>
VI00GF000100	DN 100	10	<u>3.24</u>
VI00GF000125	DN 125	5	<u>4.66</u>
VI00GF000150	DN 150	5	<u>6.47</u>
VI00GF000200	DN 200	1	<u>10.76</u>
VI00GF000250	DN 250	1	<u>14.41</u>

**VI00V
VI00D**



IT: Vite e dado per flange
FR: Boulonnerie pour brides

Codice	Misura	Box	€
VI00V0016035	16X35	50	<u>0.91</u>
VI00V0016045	16X45	50	<u>0.87</u>
VI00V0016050	16X50	50	<u>0.87</u>
VI00V0016065	16X65	50	<u>1.12</u>
VI00V0016070	16X70	50	<u>1.20</u>
VI00V0016100	16X100	50	<u>1.66</u>
VI00V0016110	16X110	50	<u>2.07</u>
VI00V0020080	20X80	50	<u>2.69</u>
VI00V0020120	20X120	50	<u>4.64</u>
VI00D0000010	10	50	<u>0.18</u>
VI00D0000016	16	50	<u>0.32</u>

Valvole radiatore



IT: Valvolame e rubinetterie per riscaldamento (VT TH MT)

FR: Robinets et vannes chauffage (VT TH MT)

TH 105



IT: Valvola Radiatore Termostattizzabile Squadra attacco Tubo Ferro
FR: Robinet radiateur thermostattizable équerre avec lien pour tube fer

Codice	Misura	Box	€
TH010500300N	3/8"	10	<u>11.71</u>
TH010500500N	1/2"	10	<u>12.04</u>

TH 106



IT: Valvola Radiatore Termostattizzabile Diritta attacco Tubo Ferro
FR: Robinet radiateur thermostattizable avec lien pour tube fer

Codice	Misura	Box	€
TH010600300N	3/8"	10	<u>11.71</u>
TH010600500N	1/2"	10	<u>12.04</u>

VT 117



IT: Detentore a Squadra attacco Tubo Ferro
FR: Coude de réglage pour tube fer

Codice	Misura	Box	€
VT011700300N	3/8"	10	<u>7.06</u>
VT011700500N	1/2"	10	<u>7.68</u>
VT011700700N	3/4"	10	<u>11.96</u>

VT 119



IT: Valvola Radiatore Manuale Squadra attacco Tubo Ferro
FR: Robinet radiateur manuel équerre avec lien pour tube fer

Codice	Misura	Box	€
VT011900300N	3/8"	10	<u>7.68</u>
VT011900500N	1/2"	10	<u>8.39</u>
VT011900700N	3/4"	10	<u>14.87</u>

VT 120



IT: Valvola Radiatore Manuale Diritta attacco Tubo Ferro
FR: Robinet radiateur manuel avec lien pour tube fer

Codice	Misura	Box	€
VT012000300N	3/8"	10	<u>7.68</u>
VT012000500N	1/2"	10	<u>8.39</u>
VT012000700N	3/4"	10	<u>15.16</u>

VT 118



IT: Detentore Diritto attacco Tubo Ferro
FR: Tè de réglage pour tube fer

Codice	Misura	Box	€
VT011800300N	3/8"	10	<u>7.06</u>
VT011800500N	1/2"	10	<u>7.68</u>
VT011800700N	3/4"	10	<u>12.38</u>

IT: Valvolame e rubinetterie per riscaldamento (VT TH MT)

FR: Robinets et vannes chauffage (VT TH MT)

TH 105R



IT: Valvola Radiatore Termostatzabile Squadra attacco Tubo Rame Multistrato
FR: Robinet radiateur thermost. Équerre à compression pour tube Cuivre/Multicouche

Codice	Misura	Box	€
<u>TH0105R0300N</u>	<u>3/8"</u>	<u>10</u>	<u>11.55</u>
<u>TH0105R0500N</u>	<u>1/2"</u>	<u>10</u>	<u>12.46</u>

TH 106R



IT: Valvola Radiatore Termostatzabile Diritta attacco Tubo Rame Multistrato
FR: Robinet radiateur thermostatzable à compression pour tube Cuivre/Multicouche

Codice	Misura	Box	€
<u>TH0106R0300N</u>	<u>3/8"</u>	<u>10</u>	<u>11.84</u>
<u>TH0106R0500N</u>	<u>1/2"</u>	<u>10</u>	<u>12.46</u>

VT 117R



IT: Detentore Squadra attacco Tubo Rame Multistrato
FR: Coude de réglage à compression pour tube Cuivre/Multicouche

Codice	Misura	Box	€
<u>VT0117R0300N</u>	<u>3/8"</u>	<u>10</u>	<u>6.56</u>
<u>VT0117R0500N</u>	<u>1/2"</u>	<u>10</u>	<u>6.98</u>

VT 119R



IT: Valvola Radiatore Manuale Squadra attacco Tubo Rame Multistrato
FR: Robinet radiateur manuel équerre à compression pour tube Cuivre/Multicouche

Codice	Misura	Box	€
<u>VT0119R0300N</u>	<u>3/8"</u>	<u>10</u>	<u>7.89</u>
<u>VT0119R0500N</u>	<u>1/2"</u>	<u>10</u>	<u>8.39</u>

VT 120R



IT: Valvola Radiatore Manuale Diritta attacco Tubo Rame Multistrato
FR: Robinet radiateur manuel à compression pour tube Cuivre/Multicouche

Codice	Misura	Box	€
<u>VT0120R0300N</u>	<u>3/8"</u>	<u>10</u>	<u>7.89</u>
<u>VT0120R0500N</u>	<u>1/2"</u>	<u>10</u>	<u>8.39</u>

VT 118R



IT: Detentore Diritta attacco Tubo Rame Multistrato
FR: Tè de réglage à compression pour tube Cuivre/Multicouche

Codice	Misura	Box	€
<u>VT0118R0300N</u>	<u>3/8"</u>	<u>10</u>	<u>6.64</u>
<u>VT0118R0500N</u>	<u>1/2"</u>	<u>10</u>	<u>6.98</u>

IT: Valvolame e rubinetterie per riscaldamento (VT TH MT)

FR: Robinets et vannes chauffage (VT TH MT)

TH 108L



IT: Testa Termostatica con sensore a Liquido EN 215
FR: Tête thermostatique avec capteur liquide EN 215

Codice	Misura	Box	€
<u>TH0108L00000</u>		<u>10</u>	<u>16.00</u>

VOL 3



IT: Volantino Micrometrico per Valvola Termostatica
FR: Volant microthermique pour robinet thermostatizable

Codice	Misura	Box	€
<u>VOL03000000</u>		<u>10</u>	<u>3.45</u>

PR 112



IT: Valvolina Sfogo Aria Manuale con o-ring
FR: Robinet de puisage

Codice	Misura	Box	€
<u>PR0112002000</u>	<u>1/4"</u>	<u>10</u>	<u>1.46</u>
<u>PR0112003000</u>	<u>3/8"</u>	<u>10</u>	<u>1.82</u>
<u>PR0112005000</u>	<u>1/2"</u>	<u>10</u>	<u>2.28</u>

DC 240



IT: Adattatore per Tubo Rame
FR: Adaptateur pour tube Cuivre

Codice	Misura	Box	€
<u>DC024000310N</u>	<u>3/8"x10</u>	<u>10</u>	<u>1.77</u>
<u>DC024000312N</u>	<u>3/8"x12</u>	<u>10</u>	<u>1.77</u>
<u>DC024000512N</u>	<u>1/2"x12</u>	<u>10</u>	<u>1.77</u>
<u>DC024000514N</u>	<u>1/2"x14</u>	<u>10</u>	<u>1.77</u>
<u>DC024000515N</u>	<u>1/2"x15</u>	<u>10</u>	<u>1.77</u>
<u>DC024000516N</u>	<u>1/2"x16</u>	<u>10</u>	<u>1.77</u>

DC 283 DC 283P



IT: Adattatore per Tubo Multistrato
FR: Adaptateur pour tube multicouche

Codice	Misura	Box	€
<u>DC0283000516</u>	<u>1/2"x16</u>	<u>10</u>	<u>2.53</u>

IT: Adattatore per Tubo PEX
FR: Adaptateur pour tube PE-R

Codice	Misura	Box	€
<u>DC0283P00716</u>	<u>1/2"-16</u>	<u>10</u>	<u>2.56</u>

DC 83M DC 83P



IT: Adattatore Eurocono Tubo Multistrato
FR: Adaptateur Eurokonus pour tube Multicouche

Codice	Misura	Box	€
<u>DC0083M00716</u>	<u>3/4"x16</u>	<u>10</u>	<u>3.45</u>
<u>DC0083M00720</u>	<u>3/4"x20</u>	<u>10</u>	<u>3.67</u>

IT: Adattatore Eurocono Tubo PEX
FR: Adaptateur Eurokonus pour tube PE-R

Codice	Misura	Box	€
<u>DC0083P00716</u>	<u>3/4"x16</u>	<u>10</u>	<u>3.45</u>
<u>DC0083P00717</u>	<u>3/4"x17</u>	<u>10</u>	<u>3.45</u>
<u>DC0083P00720</u>	<u>3/4"x20</u>	<u>10</u>	<u>3.67</u>

Collettori



IT: Collettori di distribuzione (CL CP)

FR: Collecteurs distribution (CL CP)

CL 82R



IT: Collettore di Distribuzione con Valvola di Chiusura due vie
FR: Collecteur de distribution deux départs

Codice	Misura	Box	€
CL082R0705N	3/4"x 1/2"	1	15.35
CL082R1007N	1"x 3/4"	1	22.17

CL 83R



IT: Collettore di Distribuzione con Valvola di Chiusura Tre vie
FR: Collecteur de distribution trois départs

Codice	Misura	Box	€
CL083R0705N	3/4"x 1/2"	1	23.03
CL083R1007N	1"x 3/4"	1	33.26

CL 84R



IT: Collettore di Distribuzione con Valvola di Chiusura quattro vie
FR: Collecteur de distribution quatre départs

Codice	Misura	Box	€
CL084R0705N	3/4"x 1/2"	1	30.70
CL084R1007N	1"x 3/4"	1	44.35

CL 85R



IT: Collettore di Distribuzione con Valvola di Chiusura cinque vie
FR: Collecteur de distribution cinq départs

Codice	Misura	Box	€
CL085R0705N	3/4"x 1/2"	1	38.38

CL 86R



IT: Collettore di Distribuzione con Valvola di Chiusura sei vie
FR: Collecteur de distribution six départs

Codice	Misura	Box	€
CL086R0705N	3/4"x 1/2"	1	46.05

IT: Tappo a incastro selezionatore del circuito caldo o freddo
FR: Buchon à encastrier sélecteur des circuits chaud ou froid

IT: Ogni collettore è fornito con tappi di entrambi i colori per una rapida selezione e predisposizione del circuito

FR: Chaque collecteur est fourni avec les bouchons des deux couleurs (Bleu et Rouge) pour permettre une sélection rapide des circuits

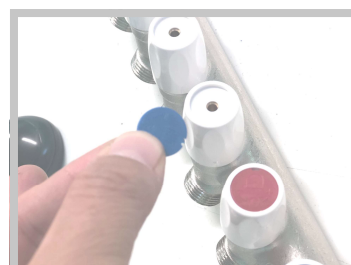

IT: Collettori di distribuzione (CL CP)

FR: Collecteurs distribution (CL CP)

CL 982M



IT: Collettore per Riscaldamento 2 vie
FR: Collecteur de distribution pour chauffage deux départs

Codice	Misura	Box	€
<u>CL0982M00705</u>	<u>3/4"x 1/2"</u>	<u>1</u>	<u>9.27</u>
<u>CL0982M01005</u>	<u>1"x 1/2"</u>	<u>1</u>	<u>12.16</u>

CL 983M



IT: Collettore per Riscaldamento 3 vie
FR: Collecteur de distribution pour chauffage trois départs

Codice	Misura	Box	€
<u>CL0983M00705</u>	<u>3/4"x 1/2"</u>	<u>1</u>	<u>12.96</u>
<u>CL0983M01005</u>	<u>1"x 1/2"</u>	<u>1</u>	<u>17.20</u>

CL 984M



IT: Collettore per Riscaldamento 4 vie
FR: Collecteur de distribution pour chauffage quatre départs

Codice	Misura	Box	€
<u>CL0984M00705</u>	<u>3/4"x 1/2"</u>	<u>1</u>	<u>16.43</u>
<u>CL0984M01005</u>	<u>1"x 1/2"</u>	<u>1</u>	<u>22.39</u>

CL 982MX



News

IT: Collettore per Riscaldamento 2 vie—
interasse 50 mm
FR: Collecteur de distribution pour chauffage deux départs—
entraxe 50 mm

Codice	Misura	Box	€
<u>CL0982MX0705</u>	<u>3/4"x 1/2"</u>	<u>1</u>	<u>9.57</u>

CL 983MX



News

IT: Collettore per Riscaldamento 3 vie—
interasse 50 mm
FR: Collecteur de distribution pour chauffage trois départs—
entraxe 50 mm

Codice	Misura	Box	€
<u>CL0983MX0705</u>	<u>3/4"x 1/2"</u>	<u>1</u>	<u>13.77</u>

CL 984MX



News

IT: Collettore per Riscaldamento 4 vie—
interasse 50 mm
FR: Collecteur de distribution pour chauffage quatre départs—
entraxe 50 mm

Codice	Misura	Box	€
<u>CL0984MX0705</u>	<u>3/4"x 1/2"</u>	<u>1</u>	<u>17.63</u>

IT: Collettori di distribuzione (CL CP)

FR: Collecteurs distribution (CL CP)

CL 985MX



IT: Collettore per Riscaldamento 5 vie—
interasse 50 mm
FR: Collecteur de distribution pour chauffage cinq départs—entraxe 50 mm

Codice	Misura	Box	€
CL0985MX0705	3/4"x 1/2"	1	25.73

CL 986MX



IT: Collettore per Riscaldamento 6 vie—
interasse 50 mm
FR: Collecteur de distribution pour chauffage six départs—entraxe 50 mm

Codice	Misura	Box	€
CL0986MX0705	3/4"x 1/2"	1	32.13

CL 985F



IT: Collettore da barra 3/4" c/foro 1/2" F-
interasse 50 mm
FR: Barre laiton 3/4" avec trous femelle 1/2"—entraxe 50 mm

Codice	Misura	Box	€
CL0985F070502	2 vie	1	18.50
CL0985F070503	3 vie	1	27.75
CL0985F070504	4 vie	1	37.00
CL0985F070505	5 vie	1	46.25
CL0985F070506	6 vie	1	55.50
CL0985F070507	7 vie	1	64.75
CL0985F070508	8 vie	1	74.00
CL0985F070509	9 vie	1	83.25
CL0985F070510	10 vie	1	92.50

DC 240



IT: Adattatore per Tubo Rame
FR: Adaptateur pour tube Cuivre

Codice	Misura	Box	€
DC024000310N	3/8"x10	10	1.77
DC024000312N	3/8"x12	10	1.77
DC024000512N	1/2"x12	10	1.77
DC024000514N	1/2"x14	10	1.77
DC024000515N	1/2"x15	10	1.77
DC024000516N	1/2"x16	10	1.77

DC 283 DC 283P



IT: Adattatore per Tubo Multistrato
FR: Adaptateur pour tube multicouche

Codice	Misura	Box	€
DC0283000516	1/2"x 16	10	2.53

IT: Adattatore per Tubo PEX
FR: Adaptateur pour tube PE-R

Codice	Misura	Box	€
DC0283P00516	1/2"-16x1.5	10	2.56

DC 83M DC 83P

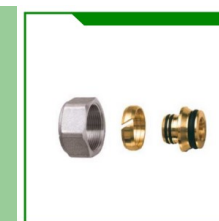

IT: Adattatore Eurocono Tubo Multistrato
FR: Adaptateur Eurokonus pour tube Multicouche

Codice	Misura	Box	€
DC0083M00716	3/4"x 16	10	3.45
DC0083M00720	3/4"x 20	10	3.67

IT: Adattatore Eurocono Tubo PEX
FR: Adaptateur Eurokonus pour tube PE-R

Codice	Misura	Box	€
DC0083P00716	3/4"x 16	10	3.45
DC0083P00717	3/4"x 17	10	3.45
DC0083P00720	3/4"x 20	10	3.67

IT: Collettori di distribuzione (CL CP)

FR: Collecteurs distribution (CL CP)

MX 592



IT: Manicotto con dado girevole a stringere per collettori
FR: Manchon écrou tournant portée plate à compression

Codice	Misura	Box	€
<u>MX0592005160</u>	<u>1/2"x 16</u>	<u>10</u>	<u>4.98</u>
<u>MX0592005200</u>	<u>1/2"x 20</u>	<u>10</u>	<u>6.23</u>

MU 881



IT: Raccordo diritto con dado girevole sede piana a pressare
FR: Mamelon femelle écrou tournant portée plate à sertir

Codice	Misura	Box	€
<u>MU0881005160</u>	<u>1/2"x 16</u>	<u>10</u>	<u>4.33</u>
<u>MU0881005200</u>	<u>1/2"x 20</u>	<u>10</u>	<u>5.84</u>

DC 10



IT: Adattatore per trasformazione da sede conica a sede piana
FR: Adaptateur alesage conique à portée plate

Codice	Misura	Box	€
<u>DC001001600</u>	<u>1/2"</u>	<u>10</u>	<u>1.96</u>

IT: Tabella di scelta rapida adattatori

FR: Sélection rapide des adaptateurs

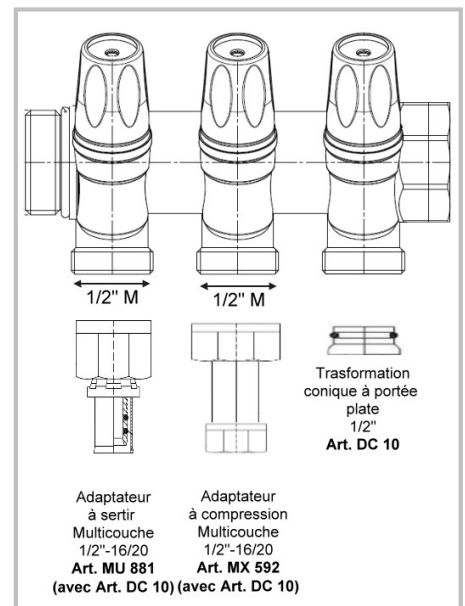
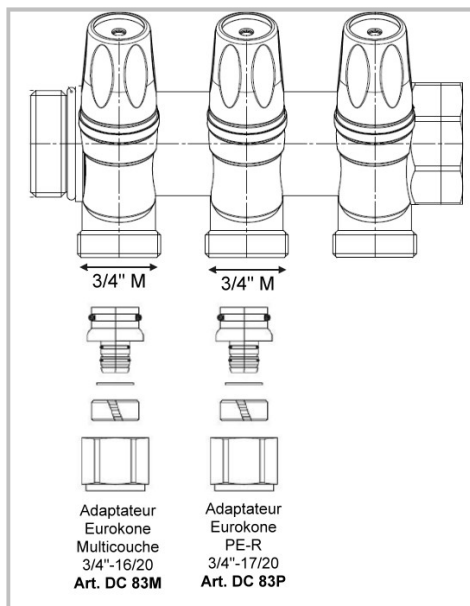
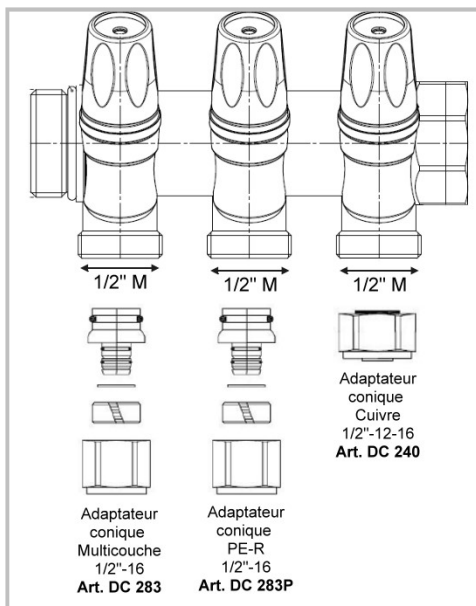

IT: Collettori di distribuzione (CL CP)

FR: Collecteurs distribution (CL CP)

CPS 856

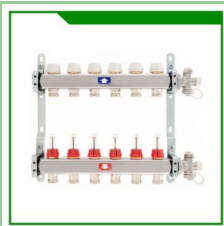

IT: Collettore INOX premontato con flussometro e valvole termo statizzabili per radiante a pavimento

FR: Collecteur INOX pre-assemblé avec débitmètres et robinets thermostatizables pour plancher chauffant

Codice	Misura	Box	€
CPS8560100703	1"	1	<u>163.99</u>
CPS8560100704	1"	1	<u>195.78</u>
CPS8560100705	1"	1	<u>235.37</u>
CPS8560100706	1"	1	<u>284.66</u>
CPS8560100707	1"	1	<u>326.26</u>
CPS8560100708	1"	1	<u>375.65</u>
CPS8560100709	1"	1	<u>404.78</u>
CPS8560100710	1"	1	<u>449.26</u>
CPS8560100711	1"	1	<u>483.48</u>
CPS8560100712	1"	1	<u>530.30</u>

CPS 854

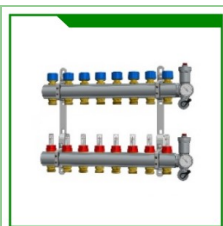

IT: Collettore in ottone da barra premontato con flussometro e valvole termostattizzabili per radiante a pavimento

FR: Collecteur laiton pre-assemblé avec débitmètres et robinets thermostatizables pour plancher chauffant

Codice	Misura	Box	€
CPS8540100703	1"	1	<u>203.92</u>
CPS8540100704	1"	1	<u>240.86</u>
CPS8540100705	1"	1	<u>277.95</u>
CPS8540100706	1"	1	<u>316.81</u>
CPS8540100707	1"	1	<u>353.90</u>
CPS8540100708	1"	1	<u>390.99</u>
CPS8540100709	1"	1	<u>429.40</u>
CPS8540100710	1"	1	<u>466.94</u>
CPS8540100711	1"	1	<u>503.88</u>
CPS8540100712	1"	1	<u>542.30</u>
CPS8540100713	1"	1	<u>579.39</u>

DC 83P



IT: Adattatore Eurocono per Tubo PEX
FR: Adaptateur pour tube PE-R Eurokonus

Codice	Misura	Box	€
DC0083P00716	3/4"x 16	10	<u>3.45</u>
DC0083P00717	3/4"x 17	10	<u>3.45</u>
DC0083P00720	3/4"x 20	10	<u>3.67</u>

CLI 508



IT: Testa termostatica per Collettori 856 Quattro Fili

FR: Tête thermostatique pour collecteur 856

Codice	Misura	Box	€
CLI508000230	230v	1	<u>46.86</u>
CLI508000240	24v	1	<u>46.86</u>

CLI 507



IT: Testa termostatica per Collettori 854 Quattro Fili

FR: Tête thermostatique pour collecteur 854

Codice	Misura	Box	€
CLI507000230	230v	1	<u>46.86</u>
CLI507000240	24v	1	<u>46.86</u>

DC 83M



IT: Adattatore Eurocono per Tubo Multi-strato

FR: Adaptateur pour tube Multicouche Eurokonus

Codice	Misura	Box	€
DC0083M00716	3/4"x 16	10	<u>3.45</u>
DC0083M00720	3/4"x 20	10	<u>3.67</u>

IT: Collettori di distribuzione (CL CP)

FR: Collecteurs distribution (CL CP)

CS 35



IT: Cassetta in Lamiera per Collettori
FR: Armoire en tôle pré-peinte pour collecteurs

Codice	Misura	Box	€
<u>CS0350000400</u>	Fino a 3 vie	1	<u>122.58</u>
<u>CS0350000600</u>	Fino a 7 vie	1	<u>157.46</u>
<u>CS0350000800</u>	Fino a 11vie	1	<u>186.62</u>
<u>CS0350001000</u>	Fino a 13vie	1	<u>250.81</u>

CS 32



IT: Cassetta in Plastica per Collettori
FR: Armoire en PVC pour collecteur

Codice	Misura	Box	€
<u>CS0320000320</u>	320 x 280	1	<u>26.94</u>
<u>CS0320000420</u>	420 x 300	1	<u>30.90</u>
<u>CS0320000520</u>	520 x 320	1	<u>33.73</u>
<u>CS0320000600</u>	600 x 310	1	<u>61.17</u>

Staffaggio



IT: Staffaggi, minuteria e accessori (ST)

FR: Supportage, chevillage et accessoires (ST)

VI 386S

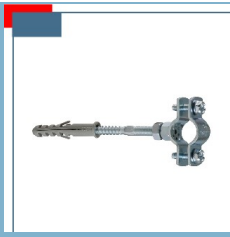

IT: Kit Collare Nudo pesante c/
tassello
FR: Kit Collier avec cheville modèle
lourd

Codice	Misura	Box	€
VI0386S00050	1/2	2	1.41
VI0386S00070	3/4	2	1.45
VI0386S00100	1"	2	1.53
VI0386S00120	1"1/4	2	1.61
VI0386S00150	1"1/2	2	1.70
VI0386S00200	2"	2	1.86
VI0386S00250	2"1/2	2	2.57
VI0386S00300	3"	2	2.73
VI0386S00400	4"	2	2.90

VI 386G



IT: Kit Collare Gommato pesante c/
tassello
FR: Kit Collier avec cheville modèle
lourd—EPDM

Codice	Misura	Box	€
VI0386G00050	1/2	2	2.88
VI0386G00070	3/4	2	3.13
VI0386G00100	1"	2	3.21
VI0386G00120	1"1/4	2	3.53
VI0386G00150	1"1/2	2	3.96
VI0386G00200	2"	2	4.43
VI0386G00250	2"1/2	2	4.68
VI0386G00300	3"	2	4.92
VI0386G00400	4"	2	5.83

VI 386ST



IT: Collare Fermatubo Nudo modello
FR: Collier nu modèle Export

Codice	Misura	Box	€
VI0386ST0030	3/8	10	0.43
VI0386ST0050	1/2	10	0.45
VI0386ST0070	3/4	10	0.50
VI0386ST0100	1"	10	0.56
VI0386ST0120	1"1/4	10	0.64
VI0386ST0150	1"1/2	10	0.75
VI0386ST0200	2"	10	0.83
VI0386ST0250	2"1/2	5	1.46
VI0386ST0300	3"	5	1.70
VI0386ST0400	4"	5	1.93
VI0386ST0500	5"	1	2.74
VI0386ST0600	6"	1	3.17

VI 386GT



IT: Collare Gommato modello Export
FR: Collier EPDM modèle Export

Codice	Misura	Box	€
VI0386GT0050	1/2	10	0.50
VI0386GT0070	3/4	10	0.55
VI0386GT0100	1"	10	0.61
VI0386GT0120	1"1/4	10	0.70
VI0386GT0150	1"1/2	10	0.83
VI0386GT0200	2"	10	0.91
VI0386GT0250	2"1/2	5	1.60
VI0386GT0300	3"	5	1.87
VI0386GT0400	4"	5	2.12
VI0386GT0400	5"	1	3.00
VI0386GT0400	6"	1	3.49

ST BARRA



IT: Barra Fissaggio c/asola
FR: Rails acier zingué

Codice	Misura	Box	€
STBARRA30X15	30x15 -2mt	1	7.66
STBARRA41X41	41x41 -3mt	1	14.49

Prezzo al metro

ST BARFIL



IT: Barra filettata in acciaio zincato
FR: Tiges filetée acier galvanisé

Codice	Misura	Box	€
STBAR081000	M8x1mt	1	1.86
STBAR101000	M10x1mt	1	1.90

Prezzo al metro

IT: Staffaggi, minuteria e accessori (ST)

FR: Supportage, chevillage et accessoires (ST)

ST KIT MRD



IT: Kit Dado, rondella e vite testa a martello
FR: Boulon de rails premonté

Codice	Misura	Box	€
STKITMRD0008 <i>(M8 x barra 40)</i>	M8	10	<u>1.99</u>
STKITMRD00083 <i>(M8 x barra 30)</i>	M8	10	<u>1.28</u>
STKITMRD0010 <i>(M10 X barra 40)</i>	M10	10	<u>2.53</u>

ST MANI

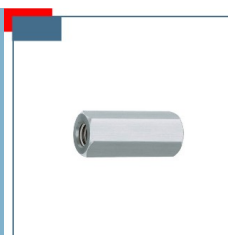

IT: Prolunga esagonale per barra filettata
FR: Ecrou exagonal pour tiges

Codice	Misura	Box	€
STMANI00008	M8	10	<u>0.46</u>
STMANI00010	M10	10	<u>0.95</u>

ST TAS



IT: Tassello Espansione ottone
FR: Cheville à expansion en laiton W-ED

Codice	Misura	Box	€
STASS000008	M8	10	<u>0.87</u>
STASS000010	M10	10	<u>1.28</u>

VI DADO

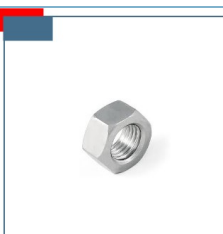

IT: Dado zincato
FR: Ecrou Galvanisé

Codice	Misura	Box	€
VI00D000008	M8	100	<u>0.11</u>
VI00D000010	M10	100	<u>0.18</u>

Prezzo confezione 100 pz

ST ROND



IT: Rondella piana zincata
FR: Rondelle plate Galvanisée

Codice	Misura	Box	€
STROND10X30	M10X32	100	<u>0.22</u>

Prezzo confezione 100 pz

CLS



IT: Mensola a muro zincata
FR: Etagère galvanisée

Codice	Misura	Box	€
CLS400	400 mm	1	<u>22.46</u>
CLS600	600 mm	1	<u>28.10</u>
CLS800	800 mm	1	<u>43.56</u>

IT: Staffaggi, minuteria e accessori (ST)

FR: Supportage, chevillage et accessoires (ST)

FB

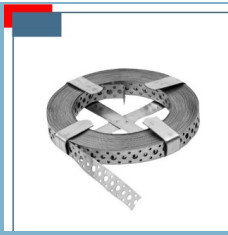

IT: Reggetta zincata
FR: Sangle galvanisée

Codice	Misura	Box	€
FB16	16x25 mt.	25	<u>27.00</u>
FB40	40x25 mt.	25	<u>40.68</u>

CANAPA



IT: Canapa giunzioni
FR: Filasse étancheité

Codice	Misura	Box	€
VV00CANAPAC1	250gr	1	<u>5.15</u>

PASTA



IT: Pasta per tenuta filetti
FR: Pate de joint filets

Codice	Misura	Box	€
VV00VIK14000	450 gr	1	<u>3.63</u>

PTFE



IT: Rotolo PTFE
FR: PTFE

Codice	Misura	Box	€
VV00VIKY63000	H12-12mt	10	<u>0.80</u>

LOCTITE



IT: Loctite filo
FR: Loctite fil

Codice	Misura	Box	€
VV00FILO150	150mt	1	<u>39.03</u>

FETTUCCIA

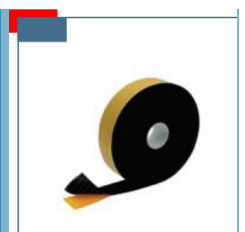

IT: Nastro anticondensa
FR: Anticondensation

Codice	Misura	Box	€
VV00NASANTIC	H50-10mt	1	<u>7.70</u>

PRODOTTI RISCALDAMENTO RADIANTE
HEATING FLOOR PRODUCTS
PRODUITS CHAUFFAGE AU SOL

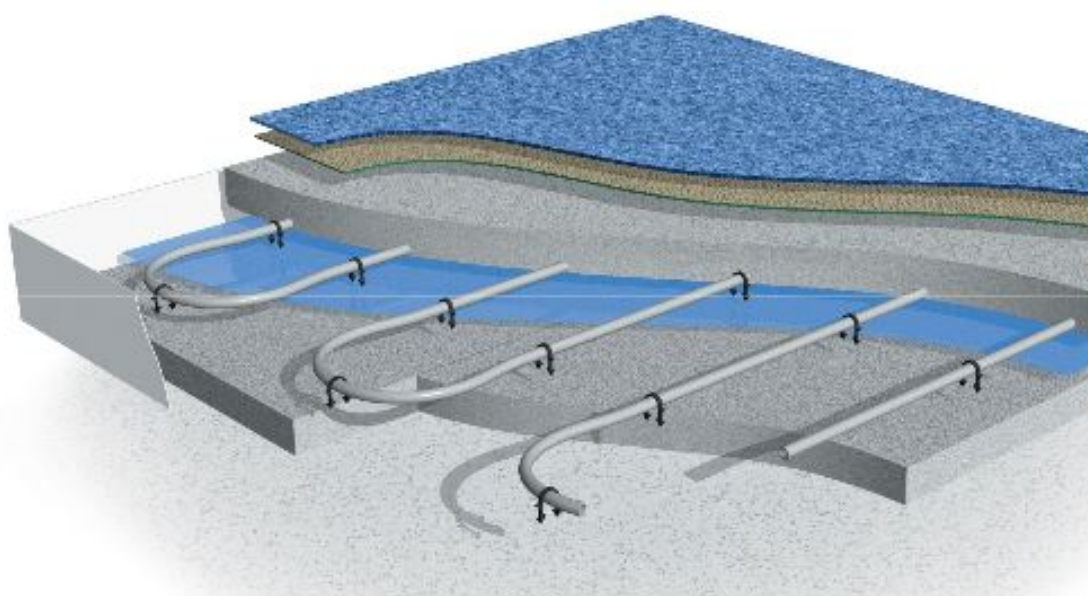

Sistemi di riscaldamento e raffrescamento radiante

Agi-comfort[®]

www.agicomfort.it

IT: Pannello Bugnato in Polistirolo Espanso
EN: Insulation panel for heating floor
FR: Panneau d'isolation pour chauffage au sol

Art AGIPLAN

Codice	Misura	Box	€
<u>AGIPLAN00030</u>	<u>10+20mm</u>	<u>10</u>	<u>16.24</u>
<u>AGIPLAN00040</u>	<u>20+20mm</u>	<u>7.5</u>	<u>18.73</u>
<u>AGIPLAN00050</u>	<u>30+20mm</u>	<u>6</u>	<u>22.23</u>



IT: Pannello in Doghe di Polistirene Estruso XPS
EN: Insulation Roll for heating floor
FR: Roll d'isolation en polystyrene pour chauffage au sol

Art AGIROLL

Codice	Misura	Box	€
<u>AGIROLL00020</u>	<u>20mm</u>	<u>15</u>	<u>16.29</u>
<u>AGIROLL00030</u>	<u>30mm</u>	<u>12</u>	<u>20.97</u>

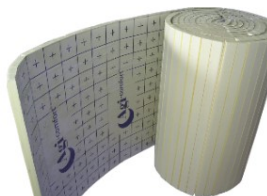

IT: Tubo Pex
EN: Pex Pipe
FR: Tube Pex

Art TUBO P

Codice	Misura	Box	€
<u>TUBOP0000017</u>	<u>17 X 2</u>	<u>100</u>	<u>1.51</u>
<u>TUBOP0000017</u>	<u>17 X 2</u>	<u>600</u>	<u>1.51</u>



Prezzi Netti a richiesta
Net prices on demand

IT: Tubo Multistrato Pex-Al-Pex
EN: Multilayer pipe Pex-Al-Pex
FR: Tube multicouche Pex-Al-Pex

Art TUBO M

Codice	Misura	Box	€
<u>TUBOM0000016</u>	<u>16 X 2</u>	<u>500</u>	<u>1.51</u>
<u>TUBOM0000020</u>	<u>20 X 2</u>	<u>100</u>	<u>2.00</u>



Prezzi Netti a richiesta
Net prices on demand

IT: Curva di sostegno
EN: Plastic elbow support
FR: Coude de soutien

Art REGGICURVA

Codice	Misura	Box	€
<u>REGGICURVA16</u>	<u>16-18</u>	<u>50</u>	<u>1.87</u>
<u>REGGICURVA20</u>	<u>20-22</u>	<u>10</u>	<u>2.53</u>



IT: Clips di fissaggio Tubo
EN: Fixing clips
FR: Clips de fissage

Art CLIPS

Codice	Misura	Box	€
<u>CLIPS0001620</u>	<u>16,17,20</u>	<u>900</u>	<u>0.14</u>



IT: Giunto di dilatazione termica
 EN: Expansion Joint
 FR: Joint de dilatation

Art GIUNTO

Codice	Misura	Box	€
<u>GIUNTO002000</u>	<u>2000 mm</u>	<u>1</u>	<u>4.91</u>



IT: Rete Metallica Antiritiro 50x50 mm
 EN: Metallic net anti-shrinkage 50x50 mm
 FR: Filette metallique contre rétrécissement 50x50 mm

Art RETE

Codice	Misura	Box	€
<u>RETE00000000</u>	<u>1 X 2</u>	<u>40</u>	<u>16.04</u>

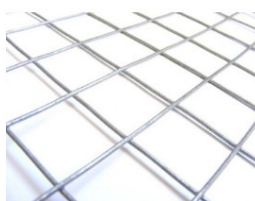

IT: Benda Perimetrale
 EN: Perimeter tape
 FR: Bande de polyethylene

Art BENDA

Codice	Misura	Box	€
<u>BENDAPER0015</u>	<u>150 mm</u>	<u>1</u>	<u>1.68</u>

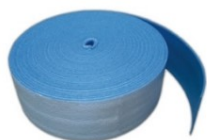

IT: Additivo per Massetto
 EN: Additive for concrete
 FR: Additive

Art FLUID

Codice	Misura	Box	€
<u>FLUIDMAS010</u>	<u>20 Lt</u>	<u>20L</u>	<u>6.27</u>



€ al litro

IT: Graffettatrice per cplis
 EN: Stapler for clips
 FR: Agrafeuse pour clips

Art GRAF

Codice	Misura	Box	€
<u>GRAF00000000</u>		<u>1</u>	<u>759.00</u>



IT: Srotolatore
 EN: Unroller
 FR: Dérouleur

Art SROTO

Codice	Misura	Box	€
<u>SROTO00000000</u>		<u>1</u>	<u>615.00</u>



Vasi di espansione





CP - Vasi espansione
CP - Vases d'expansion

RISCALDAMENTO VASI DI ESPANSIONE CON MEMBRANA FISSA Serie ERE CE							
codice	Modello	Pressione Pre carica	Pressione Max Esercizio	Attacco	Altezza	Diametro	€/PEZZO
820006	ERE 6 cert. PED	1,5 bar	4 Bar	M 3/4" Gas	250	245	22,65
820008	ERE 8 cert. PED	1,5 bar			280	245	23,20
820010	ERE 10 cert. PED	1,5 bar			330	245	24,90
820012	ERE 12 cert. PED	1,5 bar			325	285	26,95
820018DC	ERE CE 18	1,5 bar	3,5 Bar	M 3/4" Gas	395	285	37,30
820024DC	ERE CE 24	1,5 bar			420	325	43,50
820035DC	ERE CE 35	1,5 bar	5 Bar		455	380	64,55
820035DC/001	ERE CE 35 con base	1,5 bar			510	380	72,70
820035DC/002	ERE CE 35 con piedi	1,5 bar			435	380	69,95
820050DC	ERE CE 50	1,5 bar	6 Bar		590	380	76,10
820050DC/001	ERE CE 50 con base	1,5 bar			630	380	86,10
820050DC/002	ERE CE 50 con piedi	1,5 bar			565	380	81,70
820080DC	ERE CE 80	1,5 bar			690	460	123,85
820100DC	ERE CE 100	1,5 bar			810	460	146,05
820150DC	ERE CE 150	1,5 bar			970	510	199,40
820200DC	ERE CE 200	1,5 bar	M 1" Gas		985	590	256,25
820250DC	ERE CE 250	1,5 bar			1230	590	285,90
820300DC	ERE CE 300	1,5 bar			1220	650	338,75
820400DC/001	ERE CE 400 d. 650	1,5 bar		1550	650	505,45	
820500DC	ERE CE 500	2,5 bar		1575	750	594,35	
820600DC	ERE CE 600	2,5 bar		1715	750	758,85	
820700DC	ERE CE 700	2,5 bar		1930	750	887,20	
820750DC/001	ERE CE 750 d. 750	2,5 bar	2015	750	1044,55		
820750DC	ERE CE 750	2,5 bar	8 Bar	M 2" Gas	1850	800	2090,10
821000DC	ERE CE 1000	2,5 bar		F 2 1/2" Gas	2130	800	2326,65
821500DC	ERE CE 1500	2,5 bar		2550	1000	3274,70	
822000DC	ERE CE 2000	2,5 bar			1100	5763,30	



codice	Modello	Pressione Precarica	Pressione Max Esercizio	Attacco	Altezza	Diametro	€/pezzo	
ACS CE - AS CE								
510842DC	ACS CE 8	3,5 bar	10 Bar	M 3/4" Gas	305	220	34,40	
511242DC	ACS CE 12	2,5 bar			315	260	37,75	
511642DC	ACS CE 16	2,5 bar	8 Bar		350	260	39,35	
511842DC	ACS CE 18	2,5 bar			380	260	40,20	
512442DC	ACS CE 24-1" M Gas	2,5 bar		M 1" Gas	490	260	44,25	
512442DC/01	ACS CE 24-3/4" M Gas	2,5 bar		M 3/4" Gas	490	260	44,25	
502442DC	ACS CE 24-1" M Gas	2,5 bar		M 1" Gas	365	350	44,10	
502442DC/01	ACS CE 24-3/4 M Gas	2,5 bar		M 3/4" Gas	365	350	44,10	
AFE CE								
620035DC	AFE CE 35	2,5 bar	10 Bar	M 1" Gas	475	380	80,70	
620050DC	AFE CE 50	2,5 bar			720	380	110,30	
620060DC	AFE CE 60	2,5 bar			830	380	134,20	
620060DC/010	AFE CE 60 con tirante	2,5 bar			830	380	141,70	
620080DC	AFE CE 80	2,5 bar			760	460	159,15	
620080DC/010	AFE CE 80 con tirante	2,5 bar			760	460	168,10	
620100DC	AFE CE 100	2,5 bar			880	460	175,05	
620100dc/010	AFE CE 100 con tirante	2,5 bar			880	460	189,55	
620150DC	AFE CE 150	2,5 bar			1030	510	287,75	
620200DC	AFE CE 200	2,5 bar			1070	590	344,80	
620300DC	AFE CE 300	2,5 bar			M 1" 1/4 Gas	1250	650	457,80
620500DC	AFE CE 500	2,5 bar				1600	750	690,05
620750DC/001	AFE CE 750 d. 750	2,5 bar	8 Bar	F 2" Gas		2045	750	1.263,90
620750DC	AFE CE 750	2,5 bar	10 Bar	F 2" 1/2 Gas	1850	800	2.090,10	
621000DC	AFE CE 1000	2,5 bar			2130	800	2.326,65	
621500DC	AFE CE 1500	2,5 bar			2130	1000	3.274,70	
622000DC	AFE CE 2000	2,5 bar			2550	1100	5.763,30	

Isolanti per tubazioni





Famiglia KF

Guaine Elastomeriche espanse a celle chiuse



Tubi KF-COOLFLEX

Elastomero espanso a celle chiuse per l'isolamento termico

Trova la sua principale applicazione nell'isolamento di impianti di riscaldamento, impianti sanitari per acqua calda e fredda, impianti di climatizzazione.

Limiti d'impiego EN 14707	-20° a +120°C	
Conducibilità termica λ W/(m•K) EN ISO 8497 (DIN 52613)	-20 °C = 0,032 0 °C = 0,034 +20 °C = 0,036	+40 °C = 0,038 +60 °C = 0,040
Permeabilità μ EN 13469	$\mu > 7.000$	
Fuoco EN 13501-1	Tubolare - Euroclasse B _L - s2, d0	
	Lastra - Euroclasse B _L - s3, d0	
Percentuale di celle chiuse	>90%	

Codice Prodotto	Descrizione Tubo in elastomero	Lordo di vendita €/ml
KF00ST25X018	Elastomero ST 25X18	4.43
KF00ST25X022	Elastomero ST 25X22	4.97
KF00ST25X028	Elastomero ST 25X28	5.69
KF00ST25X035	Elastomero ST 25X35	6.96
KF00ST25X042	Elastomero ST 25X42	8.52
KF00ST25X048	Elastomero ST 25X48	9.58
KF00ST25X054	Elastomero ST 25X54	10.42
KF00ST25X060	Elastomero ST 25X60	11.81
KF00ST25X076	Elastomero ST 25X76	14.97
KF00ST25X089	Elastomero ST 25X89	16.47
KF00ST25X114	Elastomero ST 25X114	23.83

Codice Prodotto	Descrizione Tubo in elastomero	Lordo di vendita €/ml
KF00ST30X018	Elastomero ST 30X18	6.61
KF00ST30X022	Elastomero ST 30X22	7.69
KF00ST30X028	Elastomero ST 30X28	8.56
KF00ST30X035	Elastomero ST 30X35	9.62
KF00ST30X042	Elastomero ST 30X42	11.23
KF00ST30X048	Elastomero ST 30X48	12.43
KF00ST30X054	Elastomero ST 30X54	14.31
KF00ST30X060	Elastomero ST 30X60	15.40
KF00ST30X076	Elastomero ST 30X76	18.64
KF00ST30X089	Elastomero ST 30X89	21.49
KF00ST30X114	Elastomero ST 30X114	30.81

Codice Prodotto	Descrizione Lastra	Lordo di vendita €/mq
KFLAS00009	Lastra nera KF-Coolflex ST spessore 9 mm	7.57
KFLAS00013	Lastra nera KF-Coolflex ST spessore 13 mm	10.98
KFLAS00019	Lastra nera KF-Coolflex ST spessore 19 mm	14.00
KFLAS00025	Lastra nera KF-Coolflex ST spessore 25 mm	18.93
KFLAS00032	Lastra nera KF-Coolflex ST spessore 32 mm	23.85
KFLASAD006	Lastra nera KF-Coolflex ST spessore 6 mm adesivizzata	
KFLASAD010	Lastra nera kF-Coolflex ST spessore 10 mm adesivizzata	11.73
KFLASAD012	Lastra nera KF-Coolflex ST spessore 12 mm adesivizzata	14.80
KFLASAD020	Lastra nera KF-Coolflex ST spessore 20 mm adesivizzata	17.83
KFLASAD030	Lastra nera KF-Coolflex ST spessore 30 mm adesivizzata	27.29
KFLASADL10	Lastra nera Alluminata KF-Coolflex ST spessore 10 mm adesivizzata	17.18
KFLASADL12	Lastra nera Alluminata KF-Coolflex ST spessore 12 mm adesivizzata	20.33
KFLASADL20	Lastra nera Alluminata KF-Coolflex ST spessore 20 mm adesivizzata	23.58
KFLASADL30	Lastra nera Alluminata KF-Coolflex ST spessore 30 mm adesivizzata	33.73



Famiglia KF

Guaine Elastomeriche espanse a celle chiuse



Tubi K-Flex ST Frigo Rolls

Elastomero espanso a celle chiuse per l'isolamento frigorifero

Trova la sua principale applicazione negli impianti di refrigerazione, climatizzazione e condizionamento. Grazie al foro sulla scatola, il prodotto può essere gestito a misura discrezionale secondo la necessità, senza sprechi.

Limiti d'impiego EN 14707	-40° a +100°C	
Conducibilità termica λ W/(m•K) EN ISO 8497 (DIN 52613)	-20 °C = 0,031 0 °C = 0,033 +20 °C = 0,035	+40 °C = 0,037
Permeabilità μ EN 13469	$\mu > 10.000$	
Fuoco EN 13501-1	Tubolare - Euroclasse B _L - s2, d0	
Percentuale di celle chiuse	>90%	

Codice Prodotto	Descrizione Tubo in elastomero	Lordo di vendita €/confezione	Codice Prodotto	Descrizione Tubo in elastomero	Lordo di vendita €/confezione
KF00FR06X008	Elastomero FRIGO sp. 6X08	41.99 (ml 48)	KF00FR09X012	Elastomero FRIGO sp. 9X12	41.99 (ml 31)
KF00FR06X012	Elastomero FRIGO sp. 6X12	41.99 (ml 40)	KF00FR09X015	Elastomero FRIGO sp. 9X15	41.99 (ml 27)
KF00FR06X015	Elastomero FRIGO sp. 6X15	41.99 (ml 38)	KF00FR09X018	Elastomero FRIGO sp. 9X18	41.99 (ml 23)
KF00FR06X018	Elastomero FRIGO sp. 6X18	41.99 (ml 30)	KF00FR09X022	Elastomero FRIGO sp. 9X22	41.99 (ml 19)



Tubo Coolflex HT Solar

Elastomero espanso a celle chiuse per l'isolamento termico alta temperatura

Trova la sua principale applicazione negli impianti ad alta temperatura. Tipico impiego: la coibentazione delle tubazioni di collegamento dei pannelli solari.

Limiti d'impiego EN 14707	-40° a +150°C	
Conducibilità termica λ W/(m•K) EN ISO 8497 (DIN 52613)	0 °C = 0,040	
Permeabilità μ EN 13469	$\mu > 3.000$	
Fuoco EN 13501-1	Tubolare - E (EN 13501-1)	
Problematiche di corrosione	EN13468 pH Neutro (7±1)	

Codice Prodotto	Descrizione Tubo in elastomero	Lordo di vendita €/ml	Codice Prodotto	Descrizione Tubo in elastomero	Lordo di vendita €/ml
AR0HT13X018	Solar HT sp. 13X18	13.57	AR0HT19X018	Solar HT sp. 19X18	23.73
AR0HT13X022	Solar HT sp. 13X22	14.44	AR0HT19X022	Solar HT sp. 19X22	26.94
AR0HT13X028	Solar HT sp. 13X28	15.98	AR0HT19X028	Solar HT sp. 19X28	32.20
AR0HT13X035	Solar HT sp. 13X35	20.43	AR0HT19X035	Solar HT sp. 19X35	37.24
AR0HT13X042	Solar HT sp. 13X42	22.71	AR0HT19X042	Solar HT sp. 19X42	41.94



Famiglia KF

Prodotti per l'isolamento acustico di condotte e scarichi



K-Fonik GK

Lastra in materiale elastomerico ad alta densità

Trova la sua principale applicazione nella coibentazione acustica di elementi rumorosi come tubazioni di scarico, vani motore, attrezzature industriali, o come elemento integrativo di pannelli sandwich.

Limiti d'impiego EN 14707	-40° a +70°C	
Conducibilità termica λ W/(m•K) EN ISO 8497 (DIN 52613)	0 °C = 0,036	Formato: 2000x1000 mm
Peso	Da 4 a 8 Kg/mq	
Fuoco EN 13501-1	Lastra - Euroclasse B _L - s3, d0 IMO A653 (CE MARINE)	
Densità	2000 Kg/m3 (tolleranza +/- 10%)	

Codice Prodotto	Descrizione Lastra	Lordo di vendita €/mq
KF00FON00004	Lastra K-FONIK densità 4 Kg/mq (prodotto non adesivo)	24.86
KF00FON00005	Lastra K-FONIK densità 5 Kg/mq (prodotto non adesivo)	33.98
KF00FON00008	Lastra K-FONIK densità 8 Kg/mq (prodotto non adesivo)	58.02

PERFORMANCE ACUSTICHE ▶

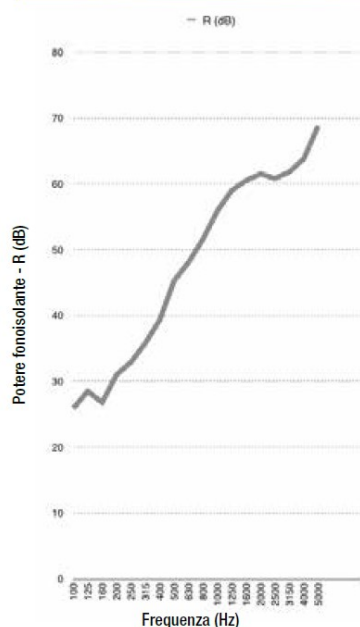

Freq. (Hz)	R (dB)
100	20,9
125	14,5
160	15,6
200	16,6
250	18,8
315	17,9
400	20,2
500	21,1
630	23,1
800	25,2
1000	27,1
1250	29,2
1600	31,5
2000	32,6
2500	33,6
3150	35,6
4000	37,4
5000	37,9

$R_w (C; C_{tr}) = 27 (-1; -4) \text{ dB}$

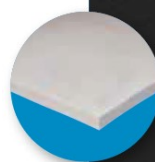

→ Famiglia KF

Prodotti per l'isolamento acustico di condotte e scarichi



K-Fonik ST-GK

Lastra in materiale gommoso ad alta densità accoppiata ad elastomeri espansi

Trova la sua principale applicazione nella coibentazione acustica di elementi rumorosi come condotte di ventilazione, tubazioni di scarico, motori UTA, Recuperatori di calore o come elemento integrativo di pannelli sandwich.

Limiti d'impiego EN 14707	-40° a +70°C	
Conducibilità termica λ W/(m•K) EN ISO 8497 (DIN 52613)	0 °C = 0,036	Formato: 2000x1000 mm
Peso	4,4 Kg/mq	
Fuoco EN 13501-1	Lastra - Euroclasse B_L - s3, d0	
Densità	2000 Kg/m3 (tolleranza +/- 10%)	

Codice Prodotto	Descrizione Lastra	Lordo di vendita €/mq
KF0FGK740304	Lastra K FONIK ST GK 74 densità 4,4 Kg/mq accoppiato 3 mm elastomero espanso (prodotto non adesivo)	56.77
KF0FGK7403A4	Lastra K FONIK ST GK 74 densità 4,4 Kg/mq accoppiato 3 mm elastomero espanso (prodotto adesivizzato)	66.51
KF0FGK721004	Lastra K FONIK ST GK 72 densità 4,4 Kg/mq accoppiato 10 mm elastomero espanso (prodotto non adesivo)	66.10
KF0FGK7210A4	Lastra K FONIK ST GK 72 densità 4,4 Kg/mq accoppiato 10 mm elastomero espanso (prodotto adesivizzato)	75.84

PERFORMANCE ACUSTICHE

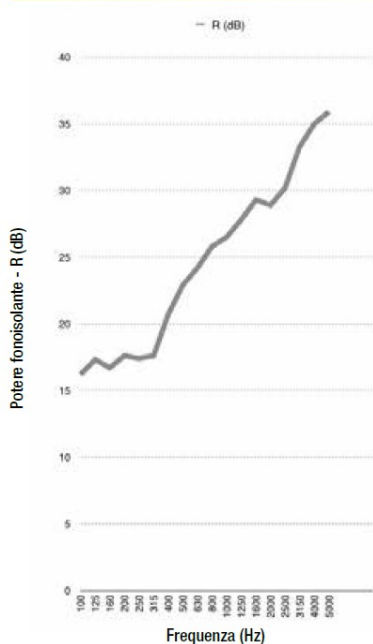

Freq. (Hz)	R (dB)
100	16,2
125	17,3
160	16,7
200	17,6
250	17,4
315	17,6
400	20,7
500	22,9
630	24,2
800	25,8
1000	26,5
1250	27,8
1600	29,3
2000	28,9
2500	30,2
3150	33,3
4000	35,0
5000	35,9

$R_w (C; C_{tr}) = 26 (0; -3) \text{ dB}$



➔ Famiglia LR
Coppelle tubolari in lana di roccia minerale



Lana di roccia in coppelle Assotherm - Sagomati tubazioni in lana di roccia nuda

Trova la sua principale applicazione nella coibentazione di tubazioni per impianti di riscaldamento, idrico sanitario, vapore e applicazioni ad alta temperatura.

Max temperatura di esercizio	+ 550 °C	
Conducibilità termica λ W/(m•K) EN 12667	0 °C = 0,034 50 °C = 0,050 100 °C = 0,053	150 °C = 0,061 200 °C = 0,071 300 °C = 0,092
Densità nominale EN 13470	90 Kg/mc	
Fuoco EN 13501-1	Euroclasse A1	
Punto di fusione DIN 4102-17	> 1000 °C	

Codice Prodotto	Descrizione Coppella lana di roccia	Lordo di vendita	Codice Prodotto	Descrizione Coppella lana di roccia	Lordo di vendita
Spessore 30 mm			Spessore 40 mm		
		€/ml			€/ml
COPROC30X021	Coppella lana di roccia Ø 21 mm	5.65	COPROC40X021	Coppella lana di roccia Ø 21 mm	8.61
COPROC30X027	Coppella lana di roccia Ø 27 mm	6.05	COPROC40X027	Coppella lana di roccia Ø 27 mm	9.11
COPROC30X033	Coppella lana di roccia Ø 33 mm	6.48	COPROC40X033	Coppella lana di roccia Ø 33 mm	9.51
COPROC30X042	Coppella lana di roccia Ø 42 mm	7.12	COPROC40X042	Coppella lana di roccia Ø 42 mm	10.41
COPROC30X048	Coppella lana di roccia Ø 48 mm	7.72	COPROC40X048	Coppella lana di roccia Ø 48 mm	10.87
COPROC30X054	Coppella lana di roccia Ø 54 mm	8.58	COPROC40X054	Coppella lana di roccia Ø 54 mm	11.94
COPROC30X060	Coppella lana di roccia Ø 60 mm	8.58	COPROC40X060	Coppella lana di roccia Ø 60 mm	11.94
COPROC30X076	Coppella lana di roccia Ø 76 mm	9.60	COPROC40X076	Coppella lana di roccia Ø 76 mm	13.32
COPROC30X089	Coppella lana di roccia Ø 89 mm	10.87	COPROC40X089	Coppella lana di roccia Ø 89 mm	14.67
COPROC30X108	Coppella lana di roccia Ø 108 mm	12.19	COPROC40X108	Coppella lana di roccia Ø 108 mm	16.20
COPROC30X114	Coppella lana di roccia Ø 114 mm	12.37	COPROC40X114	Coppella lana di roccia Ø 114 mm	16.87
COPROC30X140	Coppella lana di roccia Ø 140 mm	14.22	COPROC40X140	Coppella lana di roccia Ø 140 mm	19.00
COPROC30X169	Coppella lana di roccia Ø 169 mm	17.97	COPROC40X169	Coppella lana di roccia Ø 169 mm	21.83
COPROC30X219	Coppella lana di roccia Ø 219 mm	22.48	COPROC40X219	Coppella lana di roccia Ø 219 mm	31.18
Spessore 50 mm			Spessore 60 mm		
		€/ml			€/ml
COPROC50X021	Coppella lana di roccia Ø 21 mm	11.56	COPROC60X021	Coppella lana di roccia Ø 21 mm	15.32
COPROC50X027	Coppella lana di roccia Ø 27 mm	12.14	COPROC60X027	Coppella lana di roccia Ø 27 mm	16.02
COPROC50X033	Coppella lana di roccia Ø 33 mm	12.70	COPROC60X033	Coppella lana di roccia Ø 33 mm	16.61
COPROC50X042	Coppella lana di roccia Ø 42 mm	13.54	COPROC60X042	Coppella lana di roccia Ø 42 mm	17.60
COPROC50X048	Coppella lana di roccia Ø 48 mm	14.14	COPROC60X048	Coppella lana di roccia Ø 48 mm	14.14
COPROC50X054	Coppella lana di roccia Ø 54 mm	15.57	COPROC60X054	Coppella lana di roccia Ø 54 mm	19.96
COPROC50X060	Coppella lana di roccia Ø 60 mm	15.57	COPROC60X060	Coppella lana di roccia Ø 60 mm	19.96
COPROC50X076	Coppella lana di roccia Ø 76 mm	17.17	COPROC60X076	Coppella lana di roccia Ø 76 mm	21.75
COPROC50X089	Coppella lana di roccia Ø 89 mm	18.38	COPROC60X089	Coppella lana di roccia Ø 89 mm	23.24
COPROC50X108	Coppella lana di roccia Ø 108 mm	20.25	COPROC60X108	Coppella lana di roccia Ø 108 mm	25.33
COPROC50X114	Coppella lana di roccia Ø 114 mm	20.86	COPROC60X114	Coppella lana di roccia Ø 114 mm	26.00
COPROC50X140	Coppella lana di roccia Ø 140 mm	23.43	COPROC60X140	Coppella lana di roccia Ø 140 mm	28.86
COPROC50X169	Coppella lana di roccia Ø 169 mm	27.00	COPROC60X169	Coppella lana di roccia Ø 169 mm	32.98
COPROC50X219	Coppella lana di roccia Ø 219 mm	40.47	COPROC60X219	Coppella lana di roccia Ø 219 mm	50.36
COPROC50X273	Coppella lana di roccia Ø 273 mm	48.50	COPROC60X273	Coppella lana di roccia Ø 273 mm	60.00

→ Famiglia LR
Coppelle tubolari in lana di roccia minerale



Lana di roccia in coppella Assotherm - Sagomata curva 90° in lana di roccia nuda

Trova la sua principale applicazione nella coibentazione di tubazioni per impianti di riscaldamento, idrico sanitario, vapore e applicazioni ad alta temperatura.

Max temperatura di esercizio	+ 550 °C	
Conducibilità termica λ W/(m•K) EN 12667	0 °C = 0,034 50 °C = 0,050 100 °C = 0,053	150 °C = 0,061 200 °C = 0,071 300 °C = 0,092
Densità nominale EN 13470	90 Kg/mc	
Fuoco EN 13501-1	Euroclasse A1	
Punto di fusione DIN 4102-17	> 1000 °C	

Codice Prodotto	Descrizione Curva lana di roccia	Lordo di vendita	Codice Prodotto	Descrizione Curva lana di roccia	Lordo di vendita
Spessore 30 mm			Spessore 40 mm		
		€/ml			€/ml
CURROC30X021	Curva lana di roccia Ø 21 mm	5.65	CURROC40X021	Curva lana di roccia Ø 21 mm	8.61
CURROC30X027	Curva lana di roccia Ø 27 mm	6.05	CURROC40X027	Curva lana di roccia Ø 27 mm	9.11
CURROC30X033	Curva lana di roccia Ø 33 mm	6.48	CURROC40X033	Curva lana di roccia Ø 33 mm	9.51
CURROC30X042	Curva lana di roccia Ø 42 mm	7.12	CURROC40X042	Curva lana di roccia Ø 42 mm	10.41
CURROC30X048	Curva lana di roccia Ø 48 mm	7.72	CURROC40X048	Curva lana di roccia Ø 48 mm	10.87
CURROC30X054	Curva lana di roccia Ø 54 mm	8.58	CURROC40X054	Curva lana di roccia Ø 54 mm	11.94
CURROC30X060	Curva lana di roccia Ø 60 mm	8.58	CURROC40X060	Curva lana di roccia Ø 60 mm	11.94
CURROC30X076	Curva lana di roccia Ø 76 mm	9.60	CURROC40X076	Curva lana di roccia Ø 76 mm	13.32
CURROC30X089	Curva lana di roccia Ø 89 mm	10.87	CURROC40X089	Curva lana di roccia Ø 89 mm	14.67
CURROC30X108	Curva lana di roccia Ø 108 mm	12.19	CURROC40X108	Curva lana di roccia Ø 108 mm	16.20
CURROC30X114	Curva lana di roccia Ø 114 mm	12.37	CURROC40X114	Curva lana di roccia Ø 114 mm	16.87
CURROC30X140	Curva lana di roccia Ø 140 mm	14.22	CURROC40X140	Curva lana di roccia Ø 140 mm	19.00
CURROC30X169	Curva lana di roccia Ø 169 mm	17.97	CURROC40X169	Curva lana di roccia Ø 169 mm	21.83
Spessore 50 mm			Spessore 60 mm		
		€/ml			€/ml
CURROC50X021	Curva lana di roccia Ø 21 mm	11.56	CURROC60X021	Curva lana di roccia Ø 21 mm	15.32
CURROC50X027	Curva lana di roccia Ø 27 mm	12.14	CURROC60X027	Curva lana di roccia Ø 27 mm	16.02
CURROC50X033	Curva lana di roccia Ø 33 mm	12.70	CURROC60X033	Curva lana di roccia Ø 33 mm	16.61
CURROC50X042	Curva lana di roccia Ø 42 mm	13.54	CURROC60X042	Curva lana di roccia Ø 42 mm	17.60
CURROC50X048	Curva lana di roccia Ø 48 mm	14.14	CURROC60X048	Curva lana di roccia Ø 48 mm	14.14
CURROC50X054	Curva lana di roccia Ø 54 mm	15.57	CURROC60X054	Curva lana di roccia Ø 54 mm	19.96
CURROC50X060	Curva lana di roccia Ø 60 mm	15.57	CURROC60X060	Curva lana di roccia Ø 60 mm	19.96
CURROC50X076	Curva lana di roccia Ø 76 mm	17.17	CURROC60X076	Curva lana di roccia Ø 76 mm	21.75
CURROC50X089	Curva lana di roccia Ø 89 mm	18.38	CURROC60X089	Curva lana di roccia Ø 89 mm	23.24
CURROC50X108	Curva lana di roccia Ø 108 mm	20.25	CURROC60X108	Curva lana di roccia Ø 108 mm	25.33
CURROC50X114	Curva lana di roccia Ø 114 mm	20.86	CURROC60X114	Curva lana di roccia Ø 114 mm	26.00
CURROC50X140	Curva lana di roccia Ø 140 mm	23.43	CURROC60X140	Curva lana di roccia Ø 140 mm	28.86
CURROC50X169	Curva lana di roccia Ø 169 mm	27.00	CURROC60X169	Curva lana di roccia Ø 169 mm	32.98

Famiglia LR
Coppelle tubolari in lana di roccia minerale

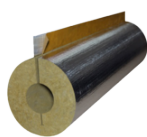

Lana di roccia in coppelle Assotherm - Sagomati tubazioni in lana di roccia rivestita con carta Kraft ALU
Trova la sua principale applicazione nella coibentazione di tubazioni per impianti di riscaldamento, idrico sanitario, vapore e applicazioni ad alta temperatura.

Max temperatura di esercizio	+ 550 °C	
Conducibilità termica λ W/(m•K) EN 12667	0 °C = 0,034 50 °C = 0,050 100 °C = 0,053	150 °C = 0,061 200 °C = 0,071 300 °C = 0,092
Densità nominale EN 13470	90 Kg/mc	
Fuoco EN 13501-1	Euroclasse A1	
Punto di fusione DIN 4102-17	> 1000 °C	

Codice Prodotto	Descrizione Coppella lana di roccia Rivestita ALU	Lordo di vendita €/ml	Codice Prodotto	Descrizione Coppella lana di roccia Rivestita ALU	Lordo di vendita €/ml
Spessore 30 mm			Spessore 40 mm		
COPROX30X021	Coppella lana roccia ALU Ø 21 mm	9.98	COPROX40X021	Coppella lana roccia ALU Ø 21 mm	13.89
COPROX30X027	Coppella lana roccia ALU Ø 27 mm	10.67	COPROX40X027	Coppella lana roccia ALU Ø 27 mm	14.69
COPROX30X033	Coppella lana roccia ALU Ø 33 mm	11.40	COPROX40X033	Coppella lana roccia ALU Ø 33 mm	15.38
COPROX30X042	Coppella lana roccia ALU Ø 42 mm	12.46	COPROX40X042	Coppella lana roccia ALU Ø 42 mm	16.71
COPROX30X048	Coppella lana roccia ALU Ø 48 mm	13.35	COPROX40X048	Coppella lana roccia ALU Ø 48 mm	17.46
COPROX30X054	Coppella lana roccia ALU Ø 54 mm	14.78	COPROX40X054	Coppella lana roccia ALU Ø 54 mm	19.12
COPROX30X060	Coppella lana roccia ALU Ø 60 mm	14.78	COPROX40X060	Coppella lana roccia ALU Ø 60 mm	19.12
COPROX30X076	Coppella lana roccia ALU Ø 76 mm	16.56	COPROX40X076	Coppella lana roccia ALU Ø 76 mm	21.24
COPROX30X089	Coppella lana roccia ALU Ø 89 mm	18.47	COPROX40X089	Coppella lana roccia ALU Ø 89 mm	23.24
COPROX30X108	Coppella lana roccia ALU Ø 108 mm	20.56	COPROX40X108	Coppella lana roccia ALU Ø 108 mm	26.90
COPROX30X114	Coppella lana roccia ALU Ø 114 mm	21.18	COPROX40X114	Coppella lana roccia ALU Ø 114 mm	27.22
COPROX30X140	Coppella lana roccia ALU Ø 140 mm	24.91	COPROX40X140	Coppella lana roccia ALU Ø 140 mm	32.08
COPROX30X169	Coppella lana roccia ALU Ø 169 mm	29.42	COPROX40X169	Coppella lana roccia ALU Ø 169 mm	36.49
Spessore 50 mm			Spessore 60 mm		
COPROX50X021	Coppella lana roccia ALU Ø 21 mm	17.80	COPROX60X021	Coppella lana roccia ALU Ø 21 mm	22.54
COPROX50X027	Coppella lana roccia ALU Ø 27 mm	18.69	COPROX60X027	Coppella lana roccia ALU Ø 27 mm	23.47
COPROX50X033	Coppella lana roccia ALU Ø 33 mm	19.53	COPROX60X033	Coppella lana roccia ALU Ø 33 mm	24.39
COPROX50X042	Coppella lana roccia ALU Ø 42 mm	20.80	COPROX60X042	Coppella lana roccia ALU Ø 42 mm	25.82
COPROX50X048	Coppella lana roccia ALU Ø 48 mm	21.70	COPROX60X048	Coppella lana roccia ALU Ø 48 mm	27.21
COPROX50X054	Coppella lana roccia ALU Ø 54 mm	23.69	COPROX60X054	Coppella lana roccia ALU Ø 54 mm	29.05
COPROX50X060	Coppella lana roccia ALU Ø 60 mm	23.69	COPROX60X060	Coppella lana roccia ALU Ø 60 mm	29.05
COPROX50X076	Coppella lana roccia ALU Ø 76 mm	26.07	COPROX60X076	Coppella lana roccia ALU Ø 76 mm	31.59
COPROX50X089	Coppella lana roccia ALU Ø 89 mm	27.90	COPROX60X089	Coppella lana roccia ALU Ø 89 mm	33.70
COPROX50X108	Coppella lana roccia ALU Ø 108 mm	33.69	COPROX60X108	Coppella lana roccia ALU Ø 108 mm	41.07
COPROX50X114	Coppella lana roccia ALU Ø 114 mm	34.03	COPROX60X114	Coppella lana roccia ALU Ø 114 mm	41.97
COPROX50X140	Coppella lana roccia ALU Ø 140 mm	39.95	COPROX60X140	Coppella lana roccia ALU Ø 140 mm	48.32
COPROX50X169	Coppella lana roccia ALU Ø 169 mm	47.11	COPROX60X169	Coppella lana roccia ALU Ø 169 mm	55.48



Famiglia PV

Prodotti per la finitura superficiale di coibentazione in PVC tipo Isogenopak



Lamina in PVC autoavvolgente tipo Isogenopak

Trova la sua principale applicazione nel rivestimento esterno a protezione delle coibentazioni installate all'interno dell'edificio e nei locali tecnici. Di facile applicazione per via della sua caratteristica autoavvolgente della tubazione e per il fissaggio mediante semplici chiodini in PVC a pressione.

Codice Prodotto	Descrizione Foglio in PVC	Lordo di Vendita €/mq
PVCROT000025	Foglio in PVC bianco/grigio 25m x 1 m	7.40



Curve in PVC prestampate bianco/grigio tipo Isogenopak

Trova la sua principale applicazione nel rivestimento di coibentazioni su gomiti e curve stampate. In versione **tipo S** per curva stampata a saldare (*raggio largo*). DIN 2605

Descrizione Curva PVC Serie S	Codice Prodotto	Lordo di vendita €/pz.	Codice Prodotto	Lordo di vendita €/pz.	Codice Prodotto	Lordo di vendita €/pz.
	Spessore 20 mm	€/pz.	Spessore 25 mm	€/pz.	Spessore 30 mm	€/pz.
Curva 90° PVC tipo "S" Ø 17	PVCCUR01720S	2.17	PVCCUR01725S	2.34	PVCCUR01730S	3.26
Curva 90° PVC tipo "S" Ø 22	PVCCUR02220S	2.44	PVCCUR02225S	2.57	PVCCUR02230S	3.41
Curva 90° PVC tipo "S" Ø 28	PVCCUR02820S	2.59	PVCCUR02825S	3.09	PVCCUR02830S	3.47
Curva 90° PVC tipo "S" Ø 35	PVCCUR03520S	2.59	PVCCUR03525S	3.49	PVCCUR03530S	3.47
Curva 90° PVC tipo "S" Ø 42	PVCCUR04220S	3.70	PVCCUR04225S	3.87	PVCCUR04230S	4.31
Curva 90° PVC tipo "S" Ø 48	PVCCUR04820S	3.81	PVCCUR04825S	4.25	PVCCUR04830S	4.69
Curva 90° PVC tipo "S" Ø 60	PVCCUR06020S	4.71	PVCCUR06025S	5.58	PVCCUR06030S	6.37
Curva 90° PVC tipo "S" Ø 76	PVCCUR07620S	6.37	PVCCUR07625S	6.29	PVCCUR07630S	7.85
Curva 90° PVC tipo "S" Ø 89	PVCCUR08920S	7.24	PVCCUR08925S	7.47	PVCCUR08930S	8.82
Curva 90° PVC tipo "S" Ø 108	PVCCUR10820S	8.88	PVCCUR10825S	9.68	PVCCUR10830S	12.79
Curva 90° PVC tipo "S" Ø 114	PVCCUR11420S	9.34	PVCCUR11425S	13.53	PVCCUR11430S	13.59
Curva 90° PVC tipo "S" Ø 140			PVCCUR14025S	17.86	PVCCUR14030S	17.97
Curva 90° PVC tipo "S" Ø 168			PVCCUR16825S	20.49	PVCCUR16830S	20.91
Curva 90° PVC tipo "S" Ø 219			PVCCUR21925S	35.47	PVCCUR21930S	34.84
	Spessore 40 mm	€/pz.	Spessore 50 mm	€/pz.	Spessore 60 mm	€/pz.
Curva 90° PVC tipo "S" Ø 22	PVCCUR02240S	4.92	PVCCUR02250S	6.48		
Curva 90° PVC tipo "S" Ø 28	PVCCUR02840S	5.41	PVCCUR02850S	7.32		
Curva 90° PVC tipo "S" Ø 35	PVCCUR03540S	5.74	PVCCUR03550S	9.38	PVCCUR03560S	12.18
Curva 90° PVC tipo "S" Ø 42	PVCCUR04240S	6.19	PVCCUR04250S	10.65	PVCCUR04260S	13.28
Curva 90° PVC tipo "S" Ø 48	PVCCUR04840S	7.32	PVCCUR04850S	10.98	PVCCUR04860S	13.76
Curva 90° PVC tipo "S" Ø 60	PVCCUR06040S	9.47	PVCCUR06050S	13.36	PVCCUR06060S	15.57
Curva 90° PVC tipo "S" Ø 76	PVCCUR07640S	12.79	PVCCUR07650S	15.55	PVCCUR07660S	18.07
Curva 90° PVC tipo "S" Ø 89	PVCCUR08940S	14.03	PVCCUR08950S	16.89	PVCCUR08960S	19.97
Curva 90° PVC tipo "S" Ø 108	PVCCUR10840S	15.40	PVCCUR10850S	18.62	PVCCUR10860S	23.04
Curva 90° PVC tipo "S" Ø 114	PVCCUR11440S	16.52	PVCCUR11450S	19.86	PVCCUR11460S	24.17
Curva 90° PVC tipo "S" Ø 140	PVCCUR14040S	20.58	PVCCUR14050S	24.01	PVCCUR14060S	28.80
Curva 90° PVC tipo "S" Ø 168	PVCCUR16840S	23.94	PVCCUR16850S	38.06	PVCCUR16860S	39.60
Curva 90° PVC tipo "S" Ø 219	PVCCUR21940S	45.61	PVCCUR21950S	55.10	PVCCUR21960S	58.83



Famiglia PV

Prodotti per la finitura superficiale di coibentazione in PVC tipo Isogenopack



Curve in PVC prestampate bianco/grigio tipo Isogenopack

Trova la sua principale applicazione nel rivestimento di coibentazioni su gomiti e curve pressofuse
In versione **tipo W** per curva in ghisa, o pressofusa in ottone (*raggio stretto*). **DIN 2505**

Descrizione	Codice	Lordo di	Codice	Lordo di	Codice	Lordo di
Curva PVC Serie W	Prodotto	vendita	Prodotto	vendita	Prodotto	vendita
	Spessore 20 mm	€/pz.	Spessore 25 mm	€/pz.	Spessore 30 mm	€/pz.
Curva 90° PVC tipo "W" Ø 17	PVCCUR01720W	2.80	PVCCUR01725W	3.11	PVCCUR01730W	4.10
Curva 90° PVC tipo "W" Ø 22	PVCCUR02220W	2.84	PVCCUR02225W	3.11	PVCCUR02230W	4.10
Curva 90° PVC tipo "W" Ø 28	PVCCUR02820W	3.11	PVCCUR02825W	3.64	PVCCUR02830W	4.23
Curva 90° PVC tipo "W" Ø 35	PVCCUR03520W	3.56	PVCCUR03525W	4.23	PVCCUR03530W	4.46
Curva 90° PVC tipo "W" Ø 42	PVCCUR04220W	4.23	PVCCUR04225W	5.15	PVCCUR04230W	5.22
Curva 90° PVC tipo "W" Ø 48	PVCCUR04820W	4.69	PVCCUR04825W	5.30	PVCCUR04830W	5.74
Curva 90° PVC tipo "W" Ø 60	PVCCUR06020W	5.64	PVCCUR06025W	6.29	PVCCUR06030W	7.30
Curva 90° PVC tipo "W" Ø 76	PVCCUR07620W	7.64	PVCCUR07625W	7.41	PVCCUR07630W	9.24
Curva 90° PVC tipo "W" Ø 89	PVCCUR08920W	8.94	PVCCUR08925W	8.98	PVCCUR08930W	10.16
Curva 90° PVC tipo "W" Ø 114	PVCCUR11420W	11.66			PVCCUR11430W	16.45
	Spessore 40 mm	€/pz.	Spessore 50 mm	€/pz.		
Curva 90° PVC tipo "W" Ø 17	PVCCUR01740W	5.60	PVCCUR01750W	7.24		
Curva 90° PVC tipo "W" Ø 22	PVCCUR02240W	5.83	PVCCUR02250W	7.49		
Curva 90° PVC tipo "W" Ø 28	PVCCUR02840W	6.29	PVCCUR02850W	8.52		
Curva 90° PVC tipo "W" Ø 35	PVCCUR03540W	7.03	PVCCUR03550W	11.19		
Curva 90° PVC tipo "W" Ø 42	PVCCUR04240W	7.38	PVCCUR04250W	12.98		
Curva 90° PVC tipo "W" Ø 48	PVCCUR04840W	8.88	PVCCUR04850W	13.42		
Curva 90° PVC tipo "W" Ø 60	PVCCUR06040W	11.42	PVCCUR06050W	16.43		
Curva 90° PVC tipo "W" Ø 76	PVCCUR07640W	16.05	PVCCUR07650W	17.63		
Curva 90° PVC tipo "W" Ø 89	PVCCUR08940W	18.39	PVCCUR08950W	19.95		
Curva 90° PVC tipo "W" Ø 114	PVCCUR11440W	20.81				

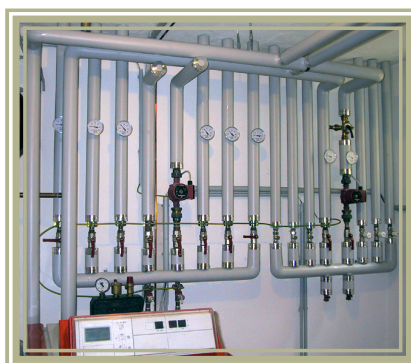

➔ Famiglia VV

Prodotti e accessori per coibentazione e rivestimenti protettivi

Gamma completa di prodotti accessori per coibentazioni e finiture protettive esterne

Immagine Prodotto	Codice Prodotto	Descrizione Prodotto	Lordo di vendita €/pz.
	VV00COLLAFOR	Colla Neoprenica per elastomeri espansi 1 Lt.	26.07
	VV00MATA050	Nastro coprigiunto nero in alluminio tipo "Matak" alt. 50 mm	20.08
	VV00NASAL100	Nastro coprigiunto in alluminio naturale tipo "Matak" alt. 100 mm	27.94
	VV00NASAL075	Nastro coprigiunto in alluminio naturale tipo "Matak" alt. 75 mm	20.96
	VV00NASGR038	Nastro isolante nero gommoso alt. 38 mm	7.51
	VV00NASGR025	Nastro isolante Bianco/Grigio coprigiunto per PVC alt. 25 mm	5.59
	PVCBEN000100	Benda Vinilica elastica in PVC grigio per barriera vapore alt. 100 mm	10.65

➔ Famiglia VV

Prodotti e accessori per coibentazione e rivestimenti protettivi

Gamma completa di prodotti accessori per coibentazioni e finiture protettive esterne

Immagine Prodotto	Codice Prodotto	Descrizione Prodotto	Lordo di vendita €/pz.
	PVC0000CHIODI	Chiodino in PVC a pressione per fissaggio foglio PVC (confez. 1000 pz)	12.26
	VVPUNTERUO	Punteruolo diritto o ad angolo per fissaggio chiodini	15.28
	VV00LAM00018	Terminale a testata in alluminio alt. 18 mm (rotolo da 10 mt)	15.15
	VV00LAM00023	Terminale a testata in alluminio alt. 23 mm (rotolo da 10 mt)	15.72
	VV00LAM00028	Terminale a testata in alluminio alt. 28 mm (rotolo da 10 mt)	17.20
	VV00LAM00038	Terminale a testata in alluminio alt. 38 mm (rotolo da 10 mt)	21.96
	VV00LAM00048	Terminale a testata in alluminio alt. 48 mm (rotolo da 10 mt)	26.72
	VV00LAM00058	Terminale a testata in alluminio alt. 58 mm (rotolo da 10 mt)	31.17
	VV00AFIL4213	Vite autofilettante zincata 4,2x13 mm (confez. 1000 pz)	29.25
	VV00AFIL4295	Vite autofilettante zincata 4,2x9,5 mm (confez. 1000 pz)	24.89
	VV00APER4213	Vite auto perforante con fresa zincata 4,2x13 mm (confez. 1000 pz)	45.84
	VV00FILOFERZ	Filo di ferro zincato d. 1.0 (prezzo al Kg.)	15.72
	VV00FILOFER7	Filo di ferro zincato d. 0.7 (prezzo al Kg.)	15.72
	VV00ARP0L019	Arpione ancoraggio h 19 (500 pz)	226..80
	VV00ARP0L032	Arpione ancoraggio h 32 (500 pz)	231.44
	VV00ARP0L051	Arpione ancoraggio h 51 (500 pz)	245.33
	VV00ARP0L076	Arpione ancoraggio h 76 (500 pz)	268.48
	VV00ARP0L095	Arpione ancoraggio h 95 (500 pz)	315.16
	VV00ARP0L114	Arpione ancoraggio h 114 (500 pz)	359.93



Famiglia REI

Prodotti per la protezione passiva al fuoco



KM FS Collari

Trovano la loro principale applicazione per usi di protezione passiva al fuoco sugli attraversamenti di tubazioni su pareti o solette.

Codice Prodotto	Descrizione Collare	Lordo di vendita €/pz
KM00FS000320	Collare resistente al fuoco d. 32	29.79
KM00FS000400	Collare resistente al fuoco d. 40	30.21
KM00FS000500	Collare resistente al fuoco d. 50	32.76
KM00FS000630	Collare resistente al fuoco d. 63	40.00
KM00FS000750	Collare resistente al fuoco d. 75	42.12
KM00FS000900	Collare resistente al fuoco d. 90	50.85
KM00FS001100	Collare resistente al fuoco d. 110	62.34
KM00FS001250	Collare resistente al fuoco d. 125	74.89
KM00FS001400	Collare resistente al fuoco d. 140	99.57
KM00FS001600	Collare resistente al fuoco d. 160	107.23

CARATTERISTICHE.: KM-FS è un collare di tenuta al fuoco, costituito da un guscio aperto in acciaio zincato contenente strisce di materiale intumescente a base grafite ad alta espansione termica KM-FF107.

Campi di impiego: per la sigillatura contro il fuoco di attraversamenti di tubi in plastica, polietilene e polipropilene e tubazioni metalliche coibentate.

DATI TECNICI

Guscio:	acciaio zincato
Contenuto:	strisce di materiale intumescente a base grafite KM-FF107
Densità:	630 kg/mc
Espansione libera:	a 400°C in 15 min
Pressione:	14 bar a 400 °C
Punto di infiammabilità:	non infiammabile
Temperatura di reazione:	250°C
Dimensioni:	Øi da 32 a 315 mm - Øe da 50 a 340 mm h 50/100 mm
Reazioni pericolose:	nessuna osservata
Stoccaggio:	in ambiente chiuso non esposto all'acqua ed all'umidità
Trasporto:	nessuna restrizione via terra nessuna restrizione ICAO/IATA-DGR (non a diretto contatto di prodotti commestibili)

APPLICAZIONE. Di facile impiego; il collare, costituito da un guscio aperto, viene fissato sul tubo da proteggere e vincolato alla struttura di compartimentazione attraversata con elementi di fissaggio di tipo metallico.

Eventuali fessure fra tubo e muro possono essere compensate con guarnizione intumescente a base grafite KM-FF108 o con stucco resistente al fuoco KM SEALER F.



Assotherm Point Milano srl

Via Cesare Pavese, 4

20090 Opera (MI)

Tel. +39 0284038305

E-mail info@assotherm-point-milano.com

Web www.assotherm-point-milano.com